

V-Belt pulleys for taper bush according to ISO4183 and DIN2211 norms V型锥孔皮带轮

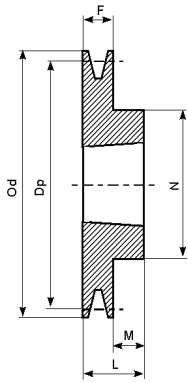

Form 1

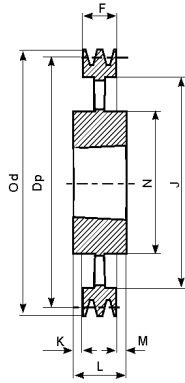

Form 4

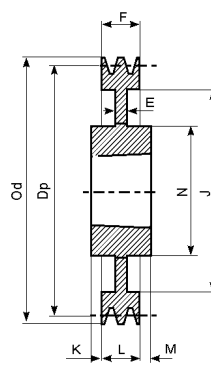

Form 7

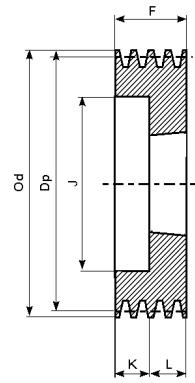

Form 9

SPZ - 1

Description 型号	Dp. 节径	Od. 外径	Form 结构	Bush No. 锥孔号	Max Bore 最大内孔	E	F	J	K	L	M	N
SPZ 50 - 01	50	54	9	1008	25		37	28	15	22		
SPZ 56 - 01	56	60	9	1008	25		37	23	15	22		
SPZ 60 - 01	60	64	9	1008	25		22			22		
SPZ 63 - 01	63	67	1	1108	28		16			22	6	62
SPZ 67 - 01	67	71	1	1108	28		16			22	6	62
SPZ 71 - 01	71	75	1	1108	28		16			22	6	62
SPZ 75 - 01	75	79	1	1108	28		16			22	6	62
SPZ 80 - 01	80	84	1	1210	32		16			25	9	75
SPZ 85 - 01	85	89	1	1210	32		16			25	9	75
SPZ 90 - 01	90	94	1	1210	32		16			25		75
SPZ 95 - 01	95	99	1	1210	32		16			25	9	75
SPZ 100 - 01	100	104	1	1210	32		16			25	9	75
SPZ 106 - 01	106	110	1	1610	42		16			25	9	80
SPZ 112 - 01	112	116	1	1610	42		16			25	9	80
SPZ 118 - 01	118	122	1	1610	42		16			25	9	80
SPZ 125 - 01	125	129	1	1610	42		16			25	9	80
SPZ 132 - 01	132	136	1	1610	42		16			25	9	80
SPZ 140 - 01	140	144	1	1610	42		16			25	9	80
SPZ 150 - 01	150	154	1	1610	42		16			25	9	80
SPZ 160 - 01	160	164	1	1610	42		16			25	9	80
SPZ 170 - 01	170	174	1	1610	42		16			25	9	80
SPZ 180 - 01	180	184	1	1610	42		16			25	9	80
SPZ 190 - 01	190	194	7	1610	42		16	161		25	9	80
SPZ 200 - 01	200	204	7	2012	50		16	172		32	16	100
SPZ 224 - 01	224	228	7	2012	50	15	16	196		32	16	100
SPZ 250 - 01	250	254	4	2012	50		16	222	8	32	8	100
SPZ 280 - 01	280	284	4	2012	50		16	252	8	32	8	100
SPZ 315 - 01	315	319	4	2012	50		16	287	8	32	8	100
SPZ 355 - 01	355	359	4	2012	50		16	326	8	32	8	112
SPZ 400 - 01	400	404	4	2012	50		16	371	8	32	8	112
SPZ 450 - 01	450	454	4	2517	60		16	421	14,5	45	14,5	120

KOBEI

V-Belt pulleys for taper bush according to ISO4183 and DIN2211 norms V型锥孔皮带轮

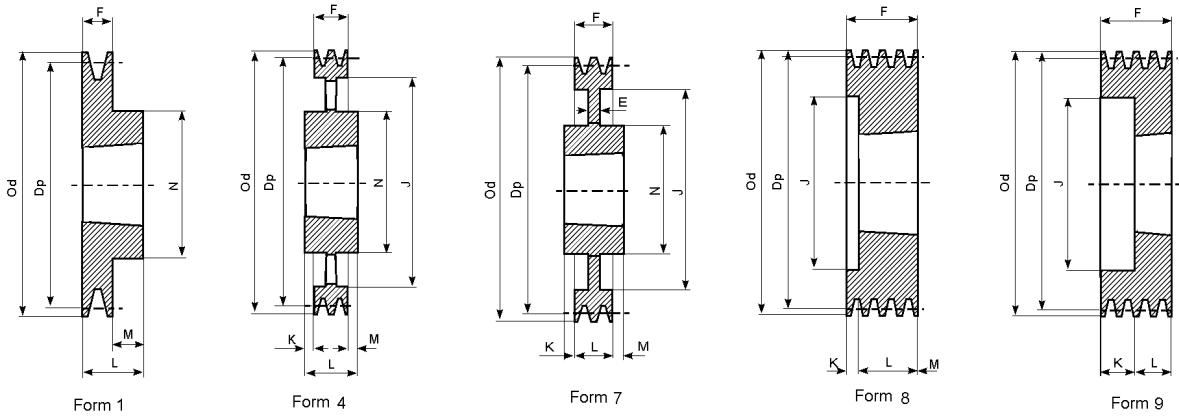

SPZ - 2

Description 型号	Dp. 节径	Od. 外径	Form 结构	Bush No. 锥孔号	Max Bore 最大内孔	E	F	J	K	L	M	N
SPZ 50 - 02	50	54	9	1008	25		49	28	27	22		
SPZ 56 - 02	56	60	9	1108	28		49	35	27	22		
SPZ 60 - 02	60	64	9	1108	28		49	36	27	22		
SPZ 63 - 02	63	67	8	1108	28		28	40	6	22		
SPZ 67 - 02	67	71	8	1108	28		28	42	6	22		
SPZ 71 - 02	71	75	8	1108	28		28	42	6	22		
SPZ 75 - 02	75	79	8	1210	32		28	51	3	25		
SPZ 80 - 02	80	84	8	1210	32		28	51	3	25		
SPZ 85 - 02	85	89	8	1610	42		28	60	3	25		
SPZ 90 - 02	90	94	8	1610	42		28	61	3	25		
SPZ 95 - 02	95	99	8	1610	42		28	66	3	25		
SPZ 100 - 02	100	104	8	1610	42		28	71	3	25		
SPZ 106 - 02	106	110	8	1610	42		28	76	3	25		
SPZ 112 - 02	112	116	8	1610	42		28	84	3	25		
SPZ 118 - 02	118	122	8	1610	42		28	90	3	25		
SPZ 125 - 02	125	129	8	1610	42		28	97	3	25		
SPZ 132 - 02	132	136	8	1610	42		28	104	3	25		
SPZ 140 - 02	140	146	8	1610	42		28	115	3	25		
SPZ 150 - 02	150	154	1	2012	50		28			32	4	100
SPZ 160 - 02	160	164	1	2012	50		28			32	4	100
SPZ 170 - 02	170	174	1	2012	50		28			32	4	100
SPZ 180 - 02	180	184	7	2012	50	10	28	152		32	4	100
SPZ 190 - 02	190	194	7	2012	50	10	28	161		32	4	100
SPZ 200 - 02	200	204	7	2012	50	10	28	171		32	4	100
SPZ 224 - 02	224	228	7	2012	50	10	28	196		32	4	100
SPZ 250 - 02	250	254	4	2012	50		28	222	2	32	2	100
SPZ 280 - 02	280	284	4	2012	50		28	252	2	32	2	100
SPZ 315 - 02	315	319	4	2012	50		28	286	2	32	2	100
SPZ 355 - 02	355	359	4	2012	50		28	326	2	32	2	112
SPZ 400 - 02	400	404	4	2517	50		28	371	8,5	45	8,5	120
SPZ 450 - 02	450	454	4	2517	60		28	421	8,5	45	8,5	120

V-Belt pulleys for taper bush according to ISO4183 and DIN2211 norms V型锥孔皮带轮

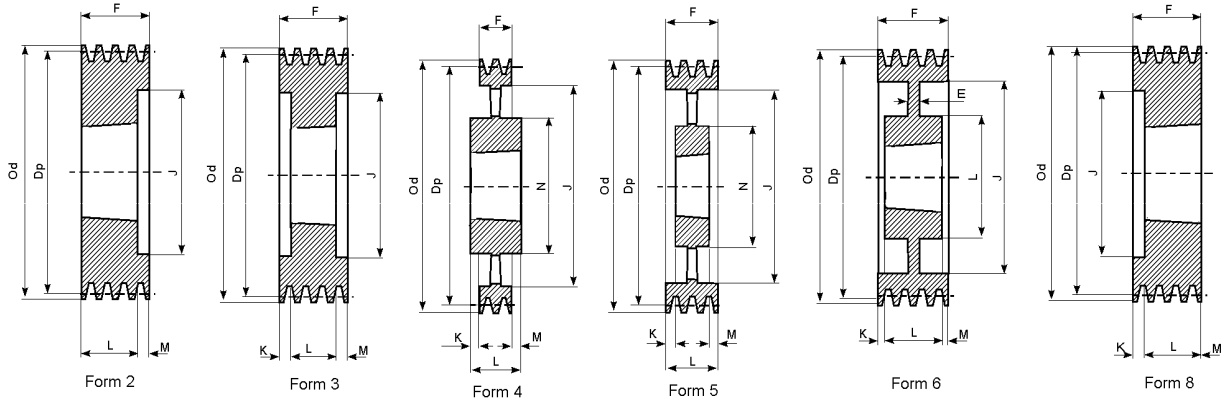

SPZ - 3

Description 型号	Dp. 节径	Od. 外径	Form 结构	Bush No. 锥孔号	Max Bore 最大内孔	E	F	J	K	L	M	N
SPZ 63x3	63	67	8	1108	28	-	40	40	-	22	-	-
SPZ 67x3	67	71	8	1108	28	-	40	42	18	22	-	-
SPZ 71x3	71	75	8	1108	28	-	40	42	18	22	-	-
SPZ 75x3	75	79	8	1210	32	-	40	51	15	25	-	-
SPZ 80x3	80	84	8	1210	32	-	40	51	15	25	-	-
SPZ 85x3	85	89	8	1610	42	-	40	60	15	25	-	-
SPZ 90x3	90	94	8	1610	42	-	40	61	15	25	-	-
SPZ 95x3	95	99	8	1610	42	-	40	66	15	25	-	-
SPZ 100x3	100	104	8	1610	42	-	40	71	15	25	-	-
SPZ 106x3	106	110	8	1610	42	-	40	76	15	25	-	-
SPZ 112x3	112	116	8	2012	50	-	40	83	8	32	-	-
SPZ 118x3	118	122	8	2012	50	-	40	90	8	32	-	-
SPZ 125x3	125	129	2	2012	50	-	40	96	-	32	8	-
SPZ 132x3	132	136	2	2012	50	-	40	103	-	32	8	-
SPZ 140x3	140	144	2	2012	50	-	40	111	-	32	8	-
SPZ 150x3	150	154	2	2012	50	-	40	121	-	32	8	-
SPZ 160x3	160	164	2	2012	50	-	40	131	-	32	8	-
SPZ 170x3	170	174	3	2012	50	-	40	141	4	32	4	-
SPZ 180x3	180	184	6	2012	50	7	40	151	-	32	8	106
SPZ 190x3	190	194	6	2012	50	10	40	161	4	32	4	112
SPZ 200x3	200	204	6	2012	50	10	40	171	4	32	4	112
SPZ 224x3	224	228	6	2012	50	12	40	195	4	32	4	112
SPZ 250x3	250	254	5	2012	50	-	40	221	4	32	4	112
SPZ 280x3	280	284	4	2517	60	-	40	251	2.5	45	2.5	124
SPZ 315x3	315	319	4	2517	60	-	40	286	2.5	45	2.5	124
SPZ 355x3	355	359	4	2517	60	-	40	326	2.5	45	2.5	124
SPZ 400x3	400	404	4	2517	60	-	40	371	2.5	45	2.5	124
SPZ 450x3	450	454	4	2517	60	-	40	421	2.5	45	2.5	124
SPZ 500x3	500	504	4	2517	60	-	40	471	2.5	45	2.5	124
SPZ 630x3	630	634	4	3020	75	-	40	601	5.5	51	5.5	150
SPZ 800x3	800	804	4	3020	75	-	40	771	5.5	51	5.5	146

KOBEI

V-Belt pulleys for taper bush according to ISO4183 and DIN2211 norms

V型锥孔皮带轮

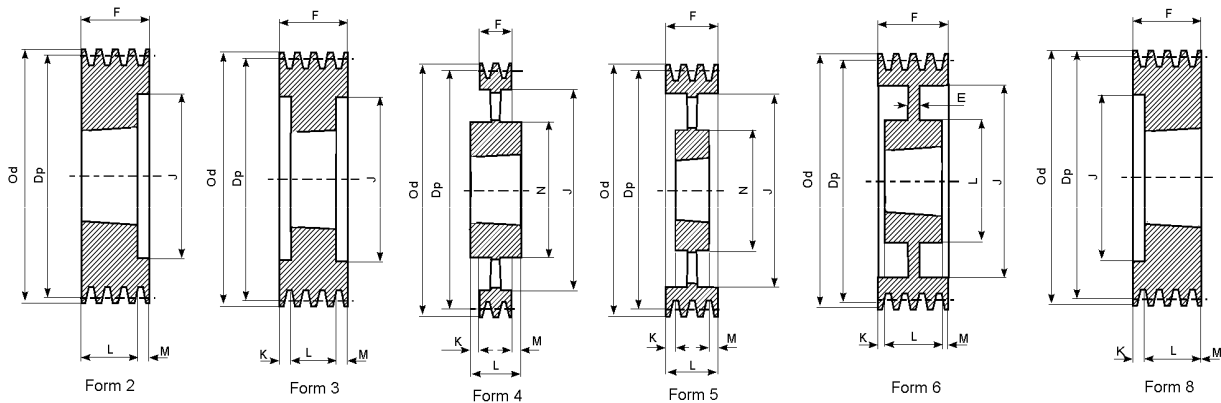

SPZ - 4

Description 型号	Dp. 节径	Od. 外径	Form 结构	Bush No. 锥孔号	Max Bore 最大内孔	E	F	J	K	L	M	N
SPZ 80x4	80	84	8	1210	32	-	52	51	27	25	-	-
SPZ 85x4	85	89	8	1610	42	-	52	60	27	25	-	-
SPZ 90x4	90	94	8	1610	42	-	52	61	27	25	-	-
SPZ 95x4	95	99	8	1610	42	-	52	66	27	25	-	-
SPZ 100x4	100	104	8	1610	42	-	52	71	27	25	-	-
SPZ 106x4	106	110	8	1610	42	-	52	76	27	25	-	-
SPZ 112x4	112	116	8	2012	50	-	52	83	20	32	-	-
SPZ 118x4	118	122	8	2012	50	-	52	90	20	32	-	-
SPZ 125x4	125	129	2	2012	50	-	52	96	-	32	20	-
SPZ 132x4	132	136	2	2012	50	-	52	103	-	32	20	-
SPZ 140x4	140	144	2	2012	50	-	52	111	-	32	20	-
SPZ 150x4	150	154	2	2517	60	-	52	121	-	45	7	-
SPZ 160x4	160	164	2	2517	60	-	52	131	-	45	7	-
SPZ 170x4	170	174	2	2517	60	-	52	141	-	45	7	-
SPZ 180x4	180	184	2	2517	60	-	52	151	-	45	7	-
SPZ 190x4	190	194	3	2517	60	-	52	161	3.5	45	3.5	-
SPZ 200x4	200	204	6	2517	60	8	52	171	3.5	45	3.5	124
SPZ 224x4	224	228	6	2517	60	14	52	195	3.5	45	3.5	124
SPZ 250x4	250	254	6	2517	60	12	52	221	3.5	45	3.5	124
SPZ 280x4	280	284	6	2517	60	14	52	251	3.5	45	3.5	124
SPZ 315x4	315	319	5	2517	60	-	52	286	3.5	45	3.5	124
SPZ 355x4	355	359	5	2517	60	-	52	326	3.5	45	3.5	124
SPZ 400x4	400	404	5	2517	60	-	52	371	3.5	45	3.5	124
SPZ 450x4	450	454	5	3020	75	-	52	421	0.5	51	0.5	146
SPZ 500x4	500	504	5	3020	75	-	52	471	0.5	51	0.5	146
SPZ 630x4	630	634	4	3030	75	-	52	601	12	76	12	146
SPZ 800x4	800	804	4	3030	75	-	52	771	12	76	12	146

KOBEI

V-Belt pulleys for taper bush according to ISO4183 and DIN2211 norms V型锥孔皮带轮

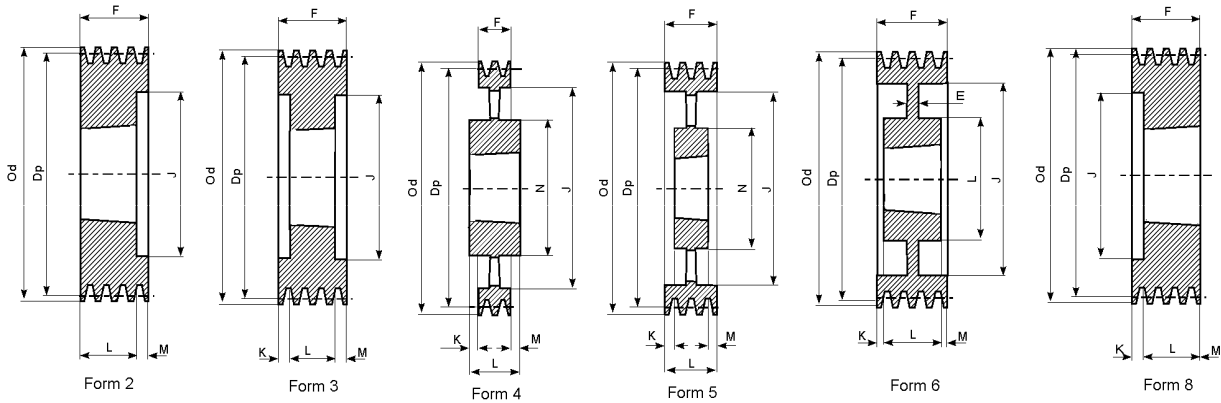

SPZ - 5

Description 型号	Dp. 节径	Od. 外径	Form 结构	Bush No. 锥孔号	Max Bore 最大内孔	E	F	J	K	L	M	N
SPZ 85x5	85	89	8	1610	42	-	64	60	39	25	-	-
SPZ 90x5	90	94	8	1610	42	-	64	61	39	25	-	-
SPZ 95x5	95	99	8	1610	42	-	64	66	39	25	-	-
SPZ 100x5	100	104	8	2012	50	-	64	71	32	32	-	-
SPZ 106x5	106	110	8	2012	50	-	64	76	32	32	-	-
SPZ 112x5	112	116	8	2012	50	-	64	83	32	32	-	-
SPZ 118x5	118	122	8	2012	50	-	64	90	32	32	-	-
SPZ 125x5	125	129	8	2012	50	-	64	96	32	32	-	-
SPZ 132x5	132	136	8	2517	60	-	64	103	19	45	19	-
SPZ 140x5	140	144	2	2517	60	-	64	111	-	45	19	-
SPZ 150x5	150	154	2	2517	60	-	64	121	-	45	19	-
SPZ 160x5	160	164	2	2517	60	-	64	131	-	45	19	-
SPZ 170x5	170	174	2	2517	60	-	64	141	-	45	19	-
SPZ 180x5	180	184	2	2517	60	-	64	151	-	45	19	-
SPZ 190x5	190	194	3	2517	60	-	64	161	9.5	45	9.5	-
SPZ 200x5	200	204	3	2517	60	-	64	171	9.5	45	9.5	-
SPZ 224x5	224	228	6	2517	60	20	64	195	9.5	45	9.5	124
SPZ 250x5	250	254	6	2517	60	16	64	221	9.5	45	9.5	124
SPZ 280x5	280	284	6	2517	60	15	64	251	9.5	45	9.5	124
SPZ 315x5	315	319	5	2517	60	-	64	286	9.5	45	9.5	124
SPZ 355x5	355	359	5	2517	60	-	64	326	9.5	45	9.5	124
SPZ 400x5	400	404	5	3020	75	-	64	371	6.5	51	6.5	146
SPZ 450x5	450	454	5	3020	75	-	64	421	6.5	51	6.5	146
SPZ 500x5	500	504	4	3030	75	-	64	471	6	76	6	146
SPZ 630x5	630	634	4	3030	75	-	64	601	6	76	6	146
SPZ 800x5	800	804	4	3535	90	-	64	771	12.5	89	12.5	178

KOBEI

V-Belt pulleys for taper bush according to ISO4183 and DIN2211 norms V型锥孔皮带轮

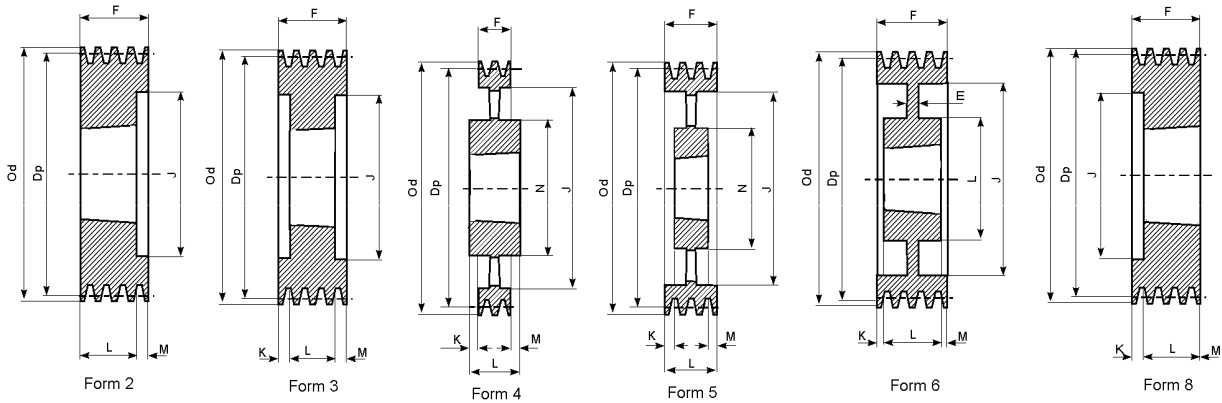

SPZ - 6

Description 型号	Dp. 节径	Od. 外径	Form 结构	Bush No. 锥孔号	Max Bore 最大内孔	E	F	J	K	L	M	N
SPZ 90x6	90	94	8	1610	42	-	76	61	51	25	-	-
SPZ 95x6	95	99	8	1610	42	-	76	66	51	25	-	-
SPZ 100x6	100	104	8	2012	50	-	76	71	44	32	-	-
SPZ 106x6	106	110	8	2012	50	-	76	76	44	32	-	-
SPZ 112x6	112	116	8	2012	50	-	76	83	44	32	-	-
SPZ 118x6	118	122	8	2517	60	-	76	90	31	45	-	-
SPZ 125x6	125	129	8	2517	60	-	76	96	31	45	-	-
SPZ 132x6	132	136	8	2517	60	-	76	103	31	45	-	-
SPZ 140x6	140	144	2	2517	60	-	76	111	-	45	31	-
SPZ 150x6	150	154	2	2517	60	-	76	121	-	45	31	-
SPZ 160x6	160	164	2	2517	60	-	76	131	-	45	31	-
SPZ 170x6	170	174	2	2517	60	-	76	141	-	45	31	-
SPZ 180x6	180	184	3	2517	60	-	76	151	15.5	45	15.5	-
SPZ 190x6	190	194	3	2517	60	-	76	161	15.5	45	15.5	124
SPZ 200x6	200	204	3	2517	60	-	76	171	15.5	45	15.5	124
SPZ 224x6	224	228	6	2517	60	26	76	195	15.5	45	15.5	124
SPZ 250x6	250	254	6	2517	60	26	76	221	15.5	45	15.5	124
SPZ 280x6	280	284	6	2517	60	15	76	251	15.5	45	15.5	124
SPZ 315x6	315	319	6	2517	60	15	76	286	15.5	45	15.5	124
SPZ 355x6	355	359	5	2517	60	-	76	326	15.5	45	15.5	124
SPZ 400x6	400	404	5	3030	75	-	76	371	-	76	-	146
SPZ 450x6	450	454	5	3030	75	-	76	421	-	76	-	146
SPZ 500x6	500	504	5	3030	75	-	76	471	-	76	-	146
SPZ 630x6	630	634	4	3535	90	-	76	601	6.5	89	6.5	175
SPZ 800x6	800	804	4	3535	90	-	76	771	6.5	89	6.5	178

KOBEI

V-Belt pulleys for taper bush according to ISO4183 and DIN2211 norms V型锥孔皮带轮

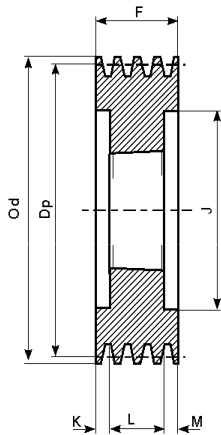

Form 3

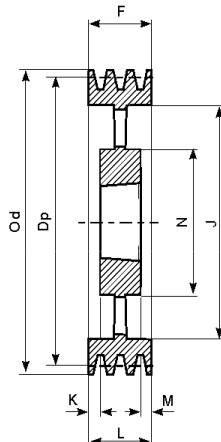

Form 5

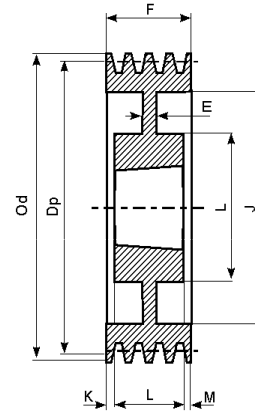

Form 6

SPZ - 8

Description 型号	Dp. 节径	Od. 外径	Form 结构	Bush No. 锥孔号	Max Bore 最大内孔	E	F	J	K	L	M	N
SPZ 140x8	140	144	3	2517	60	-	100	111	27.5	45	27.5	-
SPZ 150x8	150	154	3	2517	60	-	100	121	27.5	45	27.5	-
SPZ 160x8	160	164	3	2517	60	-	100	131	27.5	45	27.5	-
SPZ 180x8	180	184	3	2517	60	-	100	151	27.5	45	27.5	-
SPZ 200x8	200	204	3	3020	75	-	100	171	24.5	51	24.5	-
SPZ 224x8	224	228	3	3020	75	-	100	195	24.6	51	24.6	-
SPZ 250x8	250	254	6	3020	75	20	100	221	24.7	51	24.7	146
SPZ 280x8	280	284	6	3020	75	20	100	251	24.8	51	24.8	146
SPZ 355x8	355	359	5	3030	75	-	100	326	12	76	12	146
SPZ 400x8	400	404	5	3030	75	-	100	371	12	76	12	146
SPZ 450x8	450	454	5	3535	90	-	100	421	5.5	89	5.5	175

KOBEI

V-Belt pulleys for taper bush according to ISO4183 and DIN2211 norms V型锥孔皮带轮

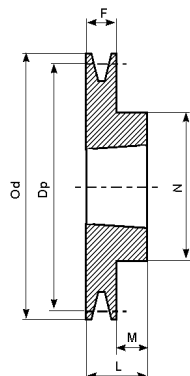

Form 1

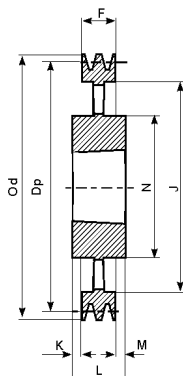

Form 4

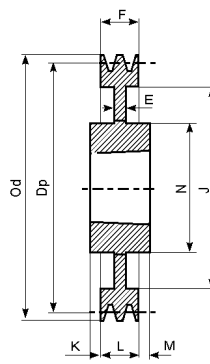

Form 7

SPA - 1

Description 型号	Dp. 节径	Od. 外径	Form 结构	Bush No. 锥孔号	Max Bore 最大内孔	E	F	J	K	L	M	N
SPA 63 - 01	63	68,5	9	1108	28		40	38	18	22		
SPA 67 - 01	67	72,5	1	1108	28		20	38		22	2	62
SPA 71 - 01	71	76,5	1	1108	28		20			22	2	62
SPA 75 - 01	75	80,5	1	1108	28		20			22	5	62
SPA 80 - 01	80	85,5	1	1210	32		20			25	5	75
SPA 85 - 01	85	90,5	1	1210	32		20			25	5	75
SPA 90 - 01	90	95,5	1	1210	32		20			25	5	75
SPA 95 - 01	95	100,5	1	1210	32		20			25	5	75
SPA 100 - 01	100	105,5	1	1610	42		20			25	5	80
SPA 106 - 01	106	111,5	1	1610	42		20			25	5	80
SPA 112 - 01	112	117,5	1	1610	42		20			25	5	80
SPA 118 - 01	118	123,5	1	1610	42		20			25	5	80
SPA 125 - 01	125	130,5	1	1610	42		20			25	5	80
SPA 132 - 01	132	137,5	1	1610	42		20			25	5	80
SPA 140 - 01	140	145,5	1	1610	42		20			25	5	80
SPA 150 - 01	150	155,5	1	1610	42		20			25	5	80
SPA 160 - 01	160	165,5	1	1610	42		20			25	5	80
SPA 170 - 01	170	175,5	1	1610	42		20			25	5	80
SPA 180 - 01	180	185,5	1	1610	42		20			25	5	80
SPA 190 - 01	190	195,5	1	1610	42		20			25	5	80
SPA 200 - 01	200	205,5	7	2012	50	10	20	165		32	12	100
SPA 224 - 01	224	229,5	7	2012	50	10	20	189		32	12	100
SPA 250 - 01	250	255,5	7	2012	50	10	20	215	6	32	6	100
SPA 280 - 01	280	285,5	7	2012	50	10	20	245		32	12	100
SPA 315 - 01	315	320,5	4	2012	50		20	280		32	12	100
SPA 355 - 01	355	360,5	4	2012	50		20	320		32	12	100
SPA 400 - 01	400	405,5	4	2012	50		20	365		32	12	100
SPA 450 - 01	450	455,5	4	2012	50		20	415		32	12	100
SPA 500 - 01	500	505,5	4	2517	60		20	465		45	25	120
SPA 630 - 01	630	635,5	4	2517	60		20	595		45	25	120

V-Belt pulleys for taper bush according to ISO4183 and DIN2211 norms V型锥孔皮带轮

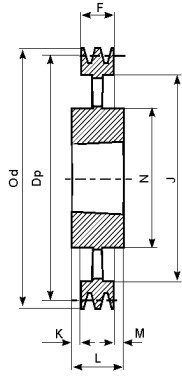

Form 4

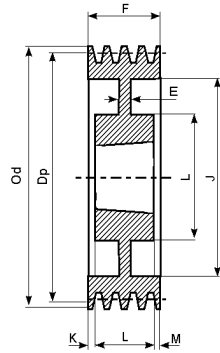

Form 6

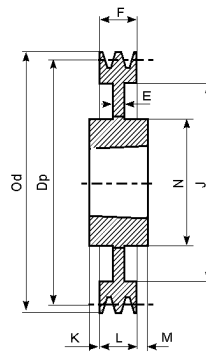

Form 7

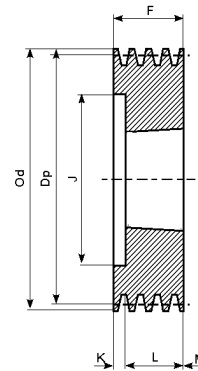

Form 8

SPA - 2

Description 型号	Dp. 节径	Od. 外径	Form 结构	Bush No. 锥孔号	Max Bore 最大内孔	E	F	J	K	L	M	N
SPA 63x2	63	68,5	8	1008	28	-	35	32.5	13	22	-	-
SPA 67x2	67	72,5	8	1108	28	-	35	37	13	22	-	-
SPA 71x2	71	76,5	8	1108	28	-	35	40	13	22	-	-
SPA 75x2	75	80,5	8	1108	28	-	35	44	13	25	-	-
SPA 80x2	80	85,5	8	1210	32	-	35	50	10	25	-	-
SPA 85x2	85	90,5	8	1210	32	-	35	55	10	25	-	-
SPA 90x2	90	95,5	8	1610	42	-	35	59	10	25	-	-
SPA 95x2	95	100,5	8	1610	42	-	35	63	10	25	-	-
SPA 100x2	100	105,5	8	1610	42	-	35	66	10	25	-	-
SPA 106x2	106	111,5	8	1610	42	-	35	72	10	25	-	-
SPA 112x2	112	117,5	8	1610	42	-	35	78	10	25	-	-
SPA 118x2	118	123,5	8	1610	42	-	35	84	10	25	-	-
SPA 125x2	125	130,5	8	1610	42	-	35	91	10	25	-	-
SPA 132x2	132	137,5	8	2012	50	-	35	98	3	32	-	-
SPA 140x2	140	145,5	8	2012	50	-	35	106	3	32	-	-
SPA 150x2	150	155,5	8	2012	50	-	35	116	3	32	-	-
SPA 160x2	160	165,5	8	2012	50	-	35	125	3	32	-	-
SPA 170x2	170	175,5	8	2012	50	-	35	135	3	32	-	-
SPA 180x2	180	185,5	6	2012	50	10	35	146	1,5	32	1,5	108
SPA 190x2	190	195,5	6	2012	50	6	35	156	-	32	3	108
SPA 200x2	200	205,5	7	2517	60	10	35	165	5	45	5	123
SPA 212x2	212	217,5	7	2517	60	18	35	177	5	45	5	123
SPA 224x2	224	229,5	7	2517	60	18	35	189	-	45	10	124
SPA 236x2	236	241,5	7	2517	60	12	35	202	-	45	10	124
SPA 250x2	250	255,5	7	2517	60	12	35	215	5	45	5	124
SPA 280x2	280	285,5	7	2517	60	12	35	245	-	45	10	124
SPA 315x2	315	320,5	7	2517	60	12	35	280	-	45	10	124
SPA 355x2	355	360,5	4	2517	60	-	35	320	-	45	10	124
SPA 400x2	400	405,5	4	2517	60	-	35	365	-	45	10	124
SPA 450x2	450	455,5	4	2517	60	-	35	465	-	45	10	124
SPA 500x2	500	505,5	4	2517	60	-	35	525	-	45	10	125
SPA 630x2	630	635,5	4	3020	75	-	35	595	8	51	18	159

KOBEI

V-Belt pulleys for taper bush according to ISO4183 and DIN2211 norms

V型锥孔皮带轮

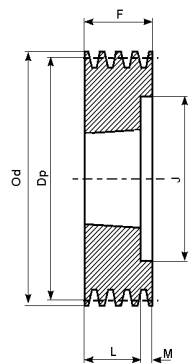

Form 2

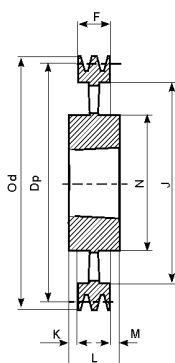

Form 4

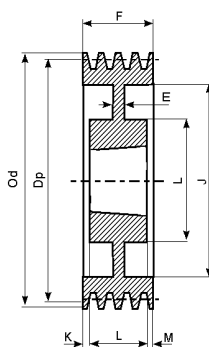

Form 6

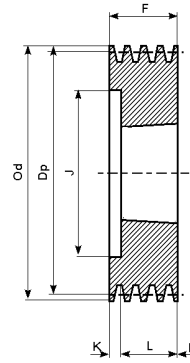

Form 8

SPA - 3

Description 型号	Dp. 节径	Od. 外径	Form 结构	Bush No. 锥孔号	Max Bore 最大内孔	E	F	J	K	L	M	N
SPA 71x3	71	76,5	8	1108	28	-	50	40	28	22	-	-
SPA 75x3	75	80,5	8	1108	28	-	50	44	28	22	-	-
SPA 80x3	80	85,5	8	1210	32	-	50	50	25	25	-	-
SPA 85x2	85	90,5	8	1210	32	-	50	55	25	25	-	-
SPA 90x3	90	95,5	8	1610	42	-	50	59	25	25	-	-
SPA 95x3	95	100,5	8	1610	42	-	50	63	25	25	-	-
SPA 100x3	100	105,5	2	1610	42	-	50	66	-	25	25	-
SPA 106x3	106	111,5	2	1610	42	-	50	72	-	25	25	-
SPA 112x3	112	117,5	8	2012	50	-	50	78	18	32	-	-
SPA 118x3	118	123,5	2	2012	50	-	50	84	-	32	18	-
SPA 125x3	125	130,5	2	2012	50	-	50	91	-	32	18	-
SPA 132x3	132	137,5	2	2012	50	-	50	98	-	32	18	-
SPA 140x3	140	145,5	8	2517	60	-	50	106	5	45	-	-
SPA 150x3	150	155,5	8	2517	60	-	50	116	5	45	-	-
SPA 160x3	160	165,5	8	2517	60	-	50	125	5	45	-	-
SPA 170x3	170	175,5	8	2517	60	-	50	135	5	45	-	-
SPA 180x3	180	185,5	8	2517	60	-	50	146	5	45	-	-
SPA 190x3	190	195,5	8	2517	60	-	50	156	5	45	-	-
SPA 200x3	200	205,5	6	2517	60	20	50	165	2,5	45	2,5	123
SPA 212x3	212	217,5	6	2517	60	20	50	177	2,5	45	2,5	123
SPA 224x3	224	229,5	6	2517	60	20	50	189	2,5	45	2,5	124
SPA 236x3	236	241,5	6	2517	60	20	50	202	2,5	45	2,5	124
SPA 250x3	250	255,5	6	2517	60	20	50	215	2,5	45	2,5	124
SPA 280x3	280	285,5	6	2517	60	20	50	245	2,5	45	2,5	124
SPA 315x3	315	320,5	4	3020	75	25	50	280	0,5	51	0,5	159
SPA 355x3	355	360,5	4	3020	75	-	50	320	0,5	51	0,5	159
SPA 400x3	400	405,5	4	3020	75	-	50	365	-	51	1	159
SPA 450x3	450	455,5	4	3020	75	-	50	415	-	51	1	159
SPA 500x3	500	505,5	4	3020	75	-	50	465	-	51	1	159
SPA 560x3	560	565,5	4	3020	75	-	50	525	-	51	1	150
SPA 630x3	630	635,5	4	3020	75	-	50	595	-	51	1	150
SPA 800x3	800	805,5	4	3535	90	-	50	765	19,05	89	19,05	175
SPA 1000x3	1000	1005,5	4	3535	90	-	50	965	19,05	89	19,05	175

KOBEI

V-Belt pulleys for taper bush according to ISO4183 and DIN2211 norms V型锥孔皮带轮

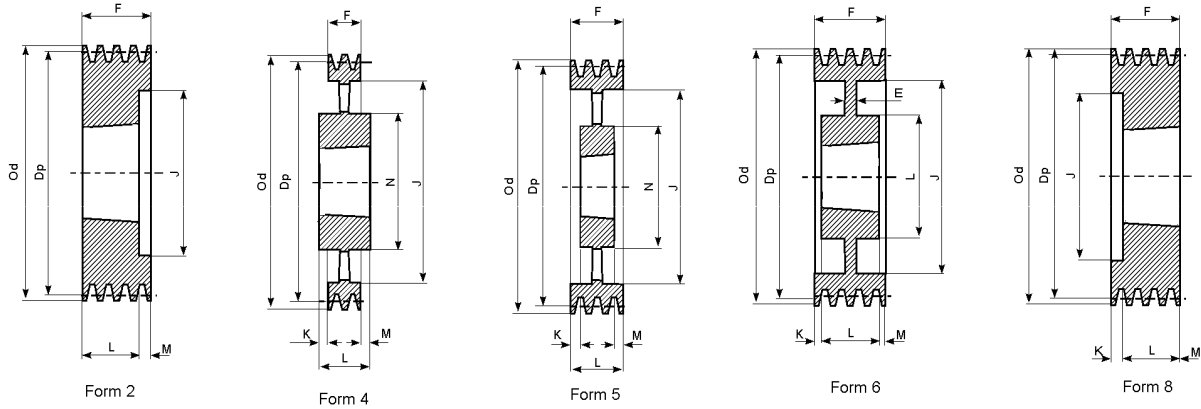

SPA - 4

Description 型号	Dp. 节径	Od. 外径	Form 结构	Bush No. 锥孔号	Max Bore 最大内孔	E	F	J	K	L	M	N
SPA 90x4	90	95,5	8	1615	42	-	65	59	27	38	-	-
SPA 95x4	95	100,5	8	1615	42	-	65	63	27	38	-	-
SPA 100x4	100	105,5	2	1615	42	-	65	66	-	38	27	-
SPA 106x4	106	111,5	8	2012	50	-	65	72	33	32	-	-
SPA 112x4	112	117,5	8	2012	50	-	65	78	33	32	-	-
SPA 118x4	118	123,5	2	2012	50	-	65	84	-	32	33	-
SPA 125x4	125	130,5	2	2012	50	-	65	91	-	32	33	-
SPA 132x4	132	137,5	2	2517	60	-	65	98	-	45	20	-
SPA 140x4	140	145,5	2	2517	60	-	65	106	-	45	20	-
SPA 150x4	150	155,5	2	2517	60	-	65	116	-	45	20	-
SPA 160x4	160	165,5	2	2517	60	-	65	125	-	45	20	-
SPA 170x4	170	175,5	2	2517	60	-	65	135	-	45	20	-
SPA 180x4	180	185,5	2	2517	60	-	65	146	-	45	20	-
SPA 190x4	190	195,5	2	2517	60	-	65	156	-	45	20	-
SPA 200x4	200	205,5	2	3020	75	-	65	165	-	51	14	-
SPA 212x4	212	217,5	2	3020	75	-	65	177	-	51	14	-
SPA 224x4	224	229,5	2	3020	75	-	65	189	-	51	14	-
SPA 236x4	236	241,5	6	3020	75	25	65	202	-	51	14	-
SPA 250x4	250	255,5	6	3020	75	20	65	215	7	51	7	159
SPA 280x4	280	285,5	6	3020	75	25	65	245	7	51	7	159
SPA 315x4	315	320,5	6	3020	75	25	65	280	7	51	7	159
SPA 355x4	355	360,5	5	3020	75	-	65	320	7	51	7	159
SPA 400x4	400	405,5	5	3020	75	-	65	365	7	51	7	159
SPA 450x4	450	455,5	5	3020	75	-	65	415	7	51	7	159
SPA 500x4	500	505,5	5	3020	75	-	65	465	7	51	7	159
SPA 560x4	560	565,5	4	3535	90	-	65	525	12	89	12	175
SPA 630x4	630	635,5	4	3535	90	-	65	595	12	89	12	175
SPA 800x4	800	805,5	4	3535	90	-	65	765	12	89	12	175
SPA 1000x4	1000	1005,5	4	4040	100	-	65	965	18.5	102	18.5	210

KOBEI

V-Belt pulleys for taper bush according to ISO4183 and DIN2211 norms

V型锥孔皮带轮

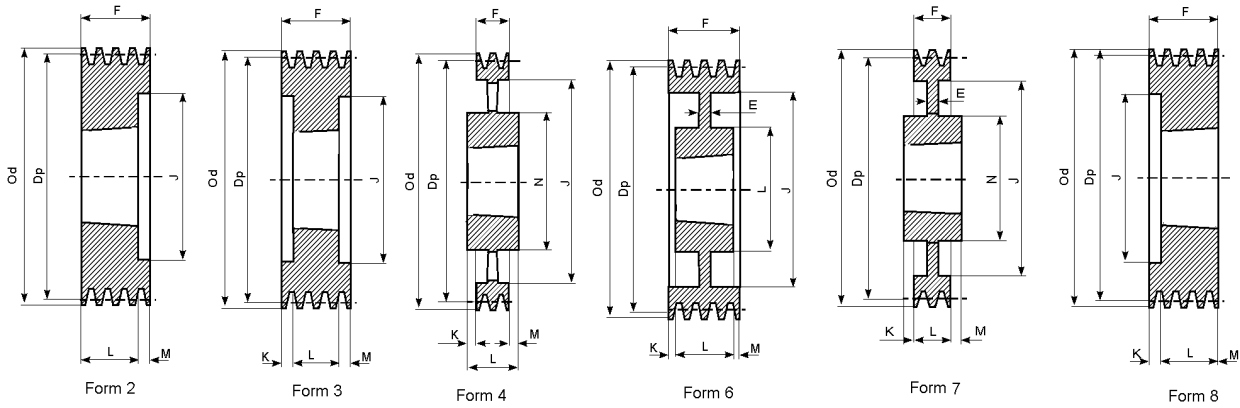

SPA - 5

Description 型号	Dp. 节径	Od. 外径	Form 结构	Bush No. 锥孔号	Max Bore 最大内孔	E	F	J	K	L	M	N
SPA 100x5	100	105,5	2	1615	42	-	80	66	-	38	42	-
SPA 106x5	106	111,5	8	2012	50	-	80	72	48	32	-	-
SPA 112x5	112	117,5	8	2012	50	-	80	78	48	32	-	-
SPA 118x5	118	123,5	2	2012	50	-	80	84	-	32	48	-
SPA 125x5	125	130,5	3	2012	50	-	80	91	24	32	24	-
SPA 132x5	132	137,5	3	2517	60	-	80	98	17,5	45	17,5	-
SPA 140x5	140	145,5	3	2517	60	-	80	106	17,5	45	17,5	-
SPA 150x5	150	155,5	3	2517	60	-	80	116	17,5	45	17,5	-
SPA 160x5	160	165,5	3	2517	60	-	80	125	17,5	45	17,5	-
SPA 170x5	170	175,5	3	2517	60	-	80	135	17,5	45	17,5	-
SPA 180x5	180	185,5	2	3020	75	-	80	146	-	51	29	-
SPA 190x5	190	195,5	3	3020	75	-	80	156	14,5	51	14,5	-
SPA 200x5	200	205,5	2	3020	75	-	80	165	14,5	51	14,5	-
SPA 212x5	212	217,5	2	3020	75	-	80	177	-	51	29	-
SPA 224x5	224	229,5	2	3020	75	-	80	189	-	51	29	-
SPA 236x5	236	241,5	6	3020	75	-	80	202	-	51	29	-
SPA 250x5	250	255,5	7	3020	75	20	80	215	14,5	51	14,5	159
SPA 280x5	280	285,5	7	3535	90	25	80	245	4,5	89	4,5	175
SPA 315x5	315	320,5	4	3535	90	25	80	280	4,5	89	4,5	175
SPA 355x5	355	360,5	4	3535	90	-	80	320	4,5	89	4,5	175
SPA 400x5	400	405,5	4	3535	90	-	80	365	4,5	89	4,5	175
SPA 450x5	450	455,5	4	3535	90	-	80	415	4,5	89	4,5	175
SPA 500x5	500	505,5	4	3535	90	-	80	465	4,5	89	4,5	175
SPA 560x5	560	565,5	4	3535	90	-	80	525	4,5	89	4,5	175
SPA 630x5	630	635,5	4	3535	90	-	80	595	4,5	89	4,5	175
SPA 800x5	800	805,5	4	4040	100	-	80	765	11	102	11	210
SPA 1000x5	1000	1005,5	4	4545	110	-	80	965	17	114	17	242

KOBEI

V-Belt pulleys for taper bush according to ISO4183 and DIN2211 norms V型锥孔皮带轮

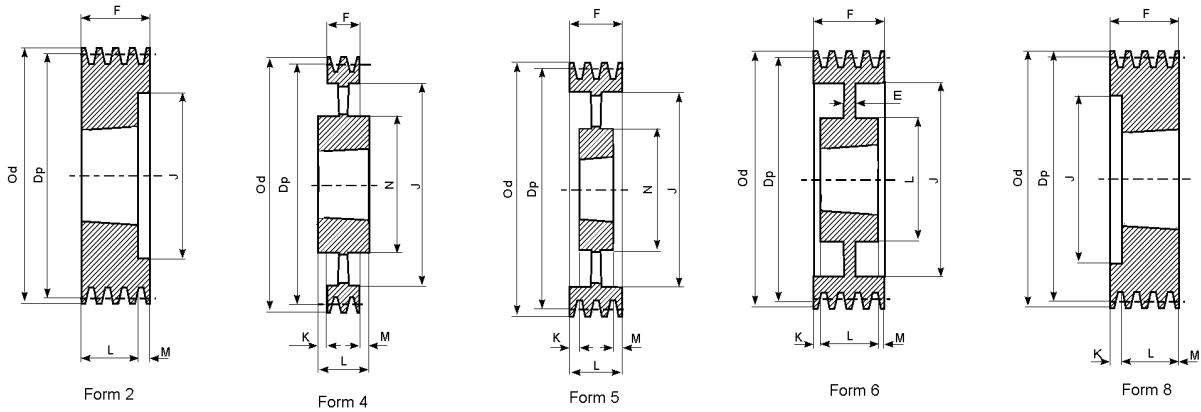

SPA - 6

Description 型号	Dp. 节径	Od. 外径	Form 结构	Bush No. 锥孔号	Max Bore 最大内孔	E	F	J	K	L	M	N
SPA 100x6	100	105,5	3	1610	42	-	95	66	30	25	40	-
SPA 106x6	106	111,5	8	2012	50	-	95	72	63	32	-	-
SPA 112x6	112	117,5	8	2012	50	-	95	78	63	32	-	-
SPA 118x6	118	123,5	8	2012	50	-	95	84	63	32	-	-
SPA 125x6	125	130,5	3	2012	50	-	95	91	31,5	32	31,5	-
SPA 132x6	132	137,5	3	2517	60	-	95	98	25	45	25	-
SPA 140x6	140	145,5	3	2517	60	-	95	106	25	45	25	-
SPA 150x6	150	155,5	3	2517	60	-	95	116	25	45	25	-
SPA 160x6	160	165,5	3	2517	60	-	95	125	25	45	25	-
SPA 180x6	180	185,5	3	3020	75	-	95	146	22	51	22	-
SPA 200x6	200	205,5	3	3020	75	-	95	165	22	51	22	-
SPA 224x6	224	229,5	3	3020	75	-	95	189	22	51	22	-
SPA 236x6	236	241,5	3	3020	75	-	95	202	22	51	22	-
SPA 250x6	250	255,5	6	3020	75	20	95	215	22	51	22	155
SPA 280x6	280	285,5	6	3535	90	25	95	245	3	89	3	175
SPA 315x6	315	320,5	6	3535	90	25	95	280	3	89	3	175
SPA 355x6	355	360,5	5	3535	90	-	95	320	3	89	3	175
SPA 400x6	400	405,5	5	3535	90	-	95	365	3	89	3	175
SPA 450x6	450	455,5	5	3535	90	-	95	415	3	89	3	175
SPA 500x6	500	505,5	5	3535	90	-	95	465	3	89	3	175
SPA 560x6	560	565,5	5	3535	90	-	95	525	3	89	3	175
SPA 630x6	630	635,5	4	4040	100	-	95	595	3,5	102	3,5	210
SPA 800x6	800	805,5	4	4040	100	-	95	765	3,5	102	3,5	210
SPA 1000x6	1000	1005,5	4	4040	110	-	95	965	9,5	114	9,5	242

KOBEI

V-Belt pulleys for taper bush according to ISO4183 and DIN2211 norms V型锥孔皮带轮

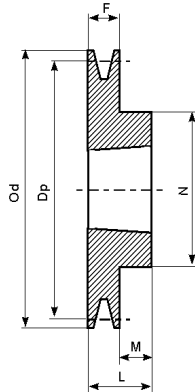

Form 1

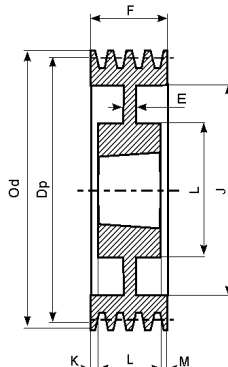

Form 6

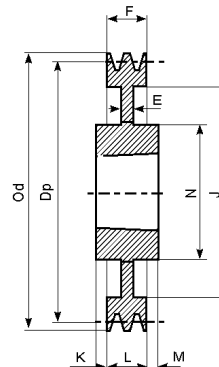

Form 7

SPB - 1

Description 型号	Dp. 节径	Od. 外径	Form 结构	Bush No. 锥孔号	Max Bore 最大内孔	E	F	J	K	L	M	N
SPB 100x1	100	107	1	1610	42	-	25	-	-	25	-	-
SPB 106x1	106	113	1	1610	42	-	25	-	-	25	-	-
SPB 112x1	112	119	1	1610	42	-	25	-	-	25	-	-
SPB 118x1	118	125	1	1610	42	-	25	-	-	25	-	-
SPB 125x1	125	132	1	1610	42	-	25	-	-	25	-	-
SPB 132x1	132	139	1	1610	42	-	25	-	-	25	-	-
SPB 140x1	140	147	1	1610	42	-	25	-	-	25	-	-
SPB 150x1	150	157	1	1610	42	-	25	-	-	25	-	-
SPB 160x1	160	167	1	1610	42	-	25	-	-	25	-	-
SPB 170x1	170	177	1	1610	42	-	25	-	-	25	-	-
SPB 180x1	180	187	6	1610	42	15	25	132	-	25	-	90
SPB 190x1	190	197	7	2012	50	15	25	147	3,5	32	3,5	104
SPB 200x1	200	207	7	2012	50	15	25	157	3,5	32	3,5	104
SPB 212x1	212	219	7	2012	50	15	25	169	3,5	32	3,5	104
SPB 224x1	224	231	7	2012	50	15	25	181	3,5	32	3,5	104
SPB 236x1	236	243	7	2012	50	15	25	193	3,5	32	3,5	104
SPB 250x1	250	257	7	2012	50	20	25	207	3,5	32	3,5	104
SPB 280x1	280	287	7	2012	50	20	25	237	3,5	32	3,5	104
SPB 300x1	300	307	7	2012	50	20	25	257	3,5	32	3,5	104
SPB 315x1	315	322	7	2012	50	20	25	272	3,5	32	3,5	104

KOBEI

V-Belt pulleys for taper bush according to ISO4183 and DIN2211 norms V型锥孔皮带轮

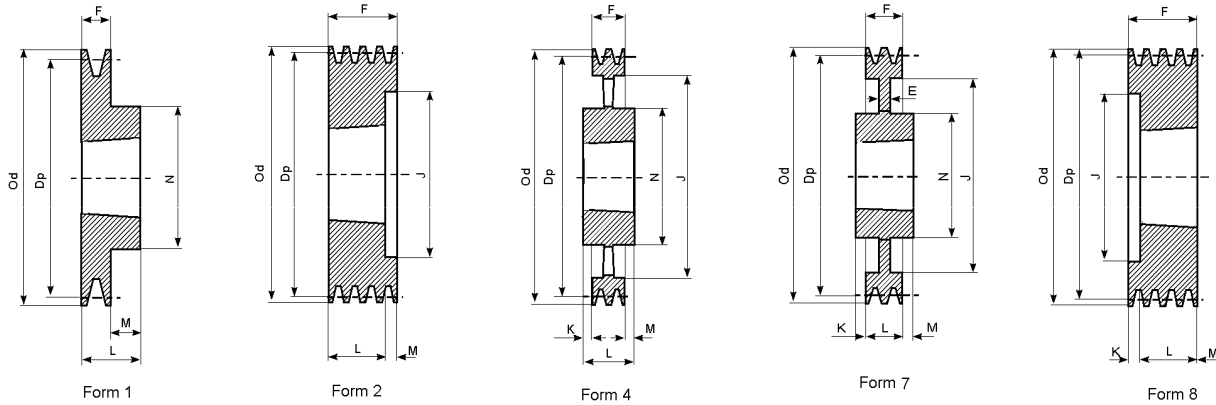

SPB - 2

Description 型号	Dp. 节径	Od. 外径	Form 结构	Bush No. 锥孔号	Max Bore 最大内孔	E	F	J	K	L	M	N
SPB 100x2	100	107	8	1610	42	-	44	62	19	25	-	-
SPB 106x2	106	113	8	1610	42	-	44	67	19	25	-	-
SPB 112x2	112	119	8	1610	42	-	44	72	19	25	-	-
SPB 118x2	118	125	2	1610	42	-	44	78	-	25	19	-
SPB 125x2	125	132	2	2012	50	-	44	82	-	32	12	-
SPB 132x2	132	139	2	2012	50	-	44	89	-	32	12	-
SPB 140x2	140	147	2	2012	50	-	44	97	-	32	12	-
SPB 150x2	150	157	2	2012	50	-	44	107	-	32	12	-
SPB 160x2	160	167	2	2012	50	-	44	117	-	32	12	-
SPB 170x2	170	177	2	2012	50	-	44	127	-	32	12	-
SPB 180x2	180	187	1	2517	60	-	44	-	-	45	1	120
SPB 190x2	190	197	1	2517	60	-	44	-	-	45	1	120
SPB 200x2	200	207	1	2517	60	-	44	-	-	45	1	117
SPB 212x2	212	219	7	2517	60	20	44	169	-	45	1	117
SPB 224x2	224	231	7	2517	60	15	44	181	-	45	1	117
SPB 236x2	236	243	7	2517	60	15	44	193	-	45	1	117
SPB 250x2	250	257	7	2517	60	20	44	207	-	45	1	125
SPB 280x2	280	287	7	2517	60	20	44	237	-	45	1	125
SPB 300x2	300	307	7	2517	60	20	44	257	-	45	1	125
SPB 315x2	315	322	7	2517	60	20	44	272	-	45	1	125
SPB 335x2	335	342	7	2517	60	20	44	292	-	45	1	125
SPB 355x2	355	362	7	3020	75	15	44	312	3,5	51	3,5	144
SPB 400x2	400	407	4	3020	75	-	44	357	3,5	51	3,5	150
SPB 450x2	450	457	4	3020	75	-	44	407	3,5	51	3,5	150
SPB 500x2	500	507	4	3020	75	-	44	457	3,5	51	3,5	150
SPB 560x2	560	567	4	3030	75	-	44	517	4	76	28	150
SPB 630x2	630	637	4	3030	75	-	44	587	16	76	16	150

KOBEI

V-Belt pulleys for taper bush according to ISO4183 and DIN2211 norms V型锥孔皮带轮

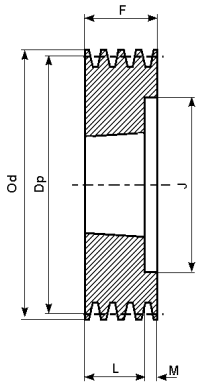

Form 2

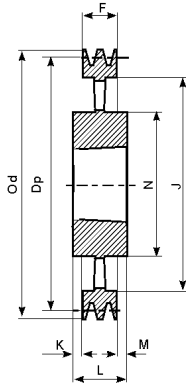

Form 4

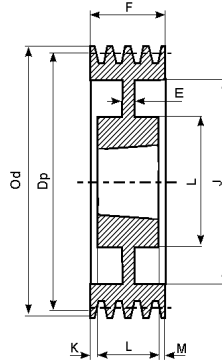

Form 6

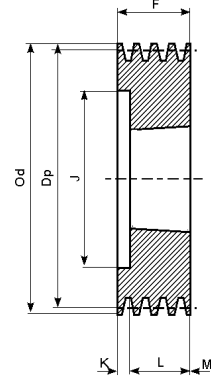

Form 8

SPB - 3

Description 型号	Dp. 节径	Od. 外径	Form 结构	Bush No. 锥孔号	Max Bore 最大内孔	E	F	J	K	L	M	N
SPB 100x3	100	107	8	1610	42	-	63	62	38	25	-	-
SPB 106x3	106	113	8	1610	42	-	63	67	38	25	-	-
SPB 112x3	112	119	8	1610	42	-	63	72	38	25	-	-
SPB 118x3	118	125	2	1610	42	-	63	78	-	25	38	-
SPB 125x3	125	132	2	2012	50	-	63	82	-	32	31	-
SPB 132x3	132	139	2	2012	50	-	63	89	-	32	31	-
SPB 140x3	140	147	2	2012	50	-	63	97	-	32	31	-
SPB 150x3	150	157	2	2517	60	-	63	107	-	45	18	-
SPB 160x3	160	167	2	2517	60	-	63	117	-	45	18	-
SPB 170x3	170	177	2	2517	60	-	63	127	-	45	18	-
SPB 180x3	180	187	2	2517	60	-	63	137	-	45	18	-
SPB 190x3	190	197	2	2517	60	-	63	147	-	45	18	-
SPB 200x3	200	207	2	2517	60	-	63	157	-	45	18	-
SPB 212x3	212	219	6	2517	60	15	63	169	-	45	18	117
SPB 224x3	224	231	6	2517	60	15	63	181	-	45	18	117
SPB 236x3	236	243	6	2517	60	15	63	193	-	45	18	117
SPB 250x3	250	257	6	3020	75	20	63	207	-	51	12	144
SPB 280x3	280	287	6	3020	75	20	63	237	6	51	6	144
SPB 300x3	300	307	6	3020	75	20	63	257	6	51	6	144
SPB 315x3	315	322	6	3020	75	20	63	272	6	51	6	144
SPB 335x3	335	342	6	3020	75	20	63	292	6	51	6	144
SPB 355x3	355	362	6	3020	75	15	63	312	6	51	6	144
SPB 400x3	400	407	4	3535	90	-	63	357	13	89	13	175
SPB 450x3	450	457	4	3535	90	-	63	407	-	89	26	175
SPB 500x3	500	507	4	3535	90	-	63	457	-	89	26	175
SPB 560x3	560	567	4	3535	90	-	63	517	-	89	26	175
SPB 630x3	630	637	4	3535	90	-	63	587	-	89	26	175
SPB 710x3	710	717	4	3535	90	-	63	664	13	89	13	175
SPB 800x3	800	807	4	3535	90	-	63	754	13	89	13	175
SPB 900x3	900	907	4	3535	90	-	63	854	13	89	13	175
SPB 1000x3	1000	1007	4	4040	100	-	63	954	19,5	102	19,5	210
SPB 1250x3	1250	1257	4	4040	100	-	63	1204	19,5	102	19,5	210

V-Belt pulleys for taper bush according to ISO4183 and DIN2211 norms

V型锥孔皮带轮

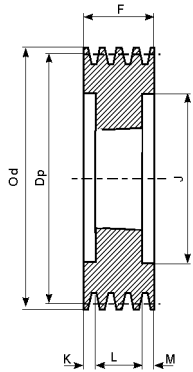

Form 3

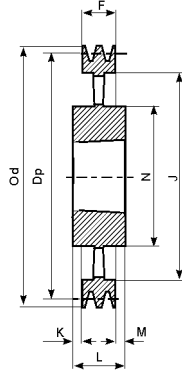

Form 4

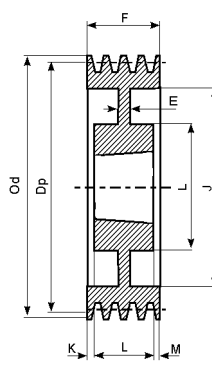

Form 6

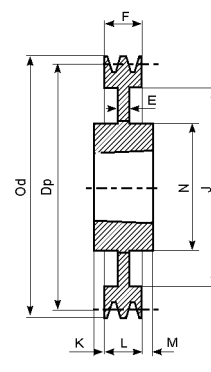

Form 7

SPB - 4

Description 型号	Dp. 节径	Od. 外径	Form 结构	Bush No. 锥孔号	Max Bore 最大内孔	E	F	J	K	L	M	N
SPB 125x4	125	132	3	2012	50	-	82	82	25	32	25	-
SPB 132x4	132	139	3	2012	50	-	82	89	25	32	25	-
SPB 140x4	140	147	3	2517	60	-	82	100	18,5	45	18,5	-
SPB 150x4	150	157	3	2517	60	-	82	107	18,5	45	18,5	-
SPB 160x4	160	167	3	2517	60	-	82	117	18,5	45	18,5	-
SPB 170x4	170	177	3	2517	60	-	82	127	18,5	45	18,5	-
SPB 180x4	180	187	3	2517	60	-	82	137	18,5	45	18,5	-
SPB 190x4	190	197	3	2517	60	-	82	147	18,5	45	18,5	-
SPB 200x4	200	207	3	3020	75	-	82	157	15,5	51	15,5	-
SPB 212x4	212	219	3	3020	75	-	82	169	15,5	51	15,5	-
SPB 224x4	224	231	3	3020	75	-	82	181	15,5	51	15,5	-
SPB 236x4	236	243	3	3020	75	-	82	193	15,5	51	15,5	-
SPB 250x4	250	257	6	3020	75	25	82	207	15,5	51	15,5	144
SPB 280x4	280	287	6	3020	75	25	82	237	15,5	51	15,5	144
SPB 300x4	300	307	7	3535	90	25	82	257	-	89	7	175
SPB 315x4	315	322	7	3535	90	25	82	272	3,5	89	3,5	175
SPB 335x4	335	342	7	3535	90	25	82	292	3,5	89	3,5	175
SPB 355x4	355	362	7	3535	90	25	82	312	3,5	89	3,5	175
SPB 400x4	400	407	4	3535	90	-	82	357	3,5	89	3,5	175
SPB 450x4	450	457	4	3535	90	-	82	407	-	89	7	175
SPB 500x4	500	507	4	3535	90	-	82	457	-	89	7	175
SPB 560x4	560	567	4	3535	90	-	82	517	-	89	7	175
SPB 630x4	630	637	4	3535	90	-	82	587	-	89	7	175
SPB 710x4	710	717	4	3535	90	-	82	664	3,5	89	3,5	175
SPB 800x4	800	807	4	4040	100	-	82	754	10	102	10	210
SPB 900x4	900	907	4	4040	100	-	82	854	10	102	10	210
SPB 1000x4	1000	1007	4	4040	100	-	82	954	10	102	10	210
SPB 1250x4	1250	1257	4	4545	100	-	82	1204	16	114	16	210

KOBEI

V-Belt pulleys for taper bush according to ISO4183 and DIN2211 norms V型锥孔皮带轮

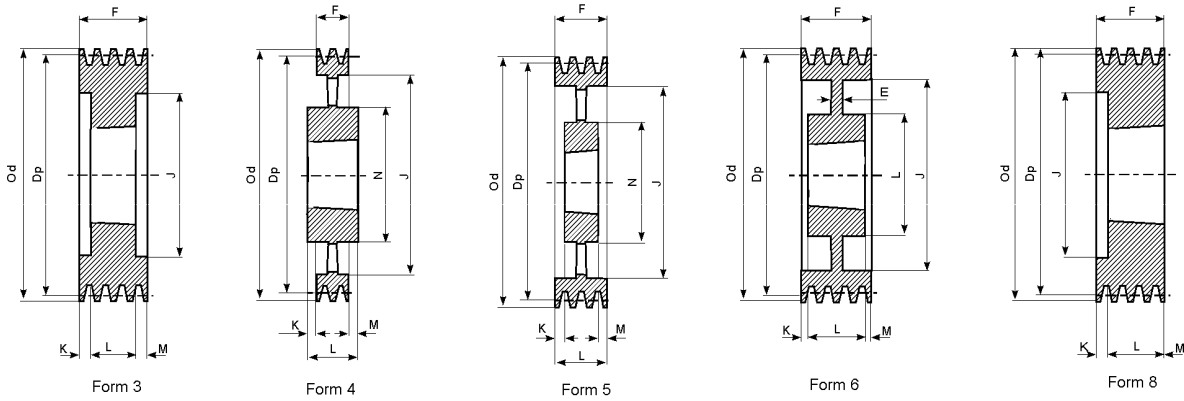

SPB - 5

Description 型号	Dp. 节径	Od. 外径	Form 结构	Bush No. 锥孔号	Max Bore 最大内孔	E	F	J	K	L	M	N
SPB 125x5	125	132	8	2012	50	-	101	87	69	32	-	-
SPB 132x5	132	139	8	2517	60	-	101	94	56	45	-	-
SPB 140x5	140	147	3	2517	60	-	101	97	28	45	28	-
SPB 150x5	150	157	3	2517	60	-	101	107	28	45	28	-
SPB 160x5	160	167	3	2517	60	-	101	117	28	45	28	-
SPB 170x5	170	177	3	3020	75	-	101	127	25	51	25	-
SPB 180x5	180	187	3	3020	75	-	101	137	25	51	25	-
SPB 190x5	190	197	3	3020	75	-	101	147	25	51	25	-
SPB 200x5	200	207	3	3020	75	-	101	157	25	51	25	-
SPB 212x5	212	219	3	3020	75	-	101	169	25	51	25	-
SPB 224x5	224	231	3	3020	75	-	101	181	25	51	25	-
SPB 236x5	236	243	3	3535	90	-	101	193	6	89	6	-
SPB 250x5	250	257	3	3535	90	-	101	207	6	89	6	-
SPB 280x5	280	287	6	3535	90	25	101	237	6	89	6	175
SPB 300x5	300	307	6	3535	90	25	101	257	6	89	6	175
SPB 315x5	315	322	6	3535	90	25	101	272	6	89	6	175
SPB 335x5	335	342	6	3535	90	25	101	292	6	89	6	175
SPB 355x5	355	362	6	3535	90	17	101	312	6	89	6	175
SPB 400x5	400	407	5	3535	90	-	101	357	6	89	6	175
SPB 450x5	450	457	5	3535	90	-	101	407	-	89	12	175
SPB 500x5	500	507	5	3535	90	-	101	457	-	89	12	175
SPB 560x5	560	567	4	4040	100	-	101	517	-	102	1	210
SPB 630x5	630	637	4	4040	100	-	101	587	-	102	1	210
SPB 710x5	710	717	4	4040	100	-	101	664	-	102	1	210
SPB 800x5	800	807	4	4040	100	-	101	754	-	102	1	210
SPB 900x5	900	907	4	4040	100	-	101	854	-	102	1	210
SPB 1000x5	1000	1007	4	4545	110	-	101	954	6.5	114	6.5	242
SPB 1250x5	1250	1257	4	4545	110	-	101	1204	6.5	114	6.5	242

V-Belt pulleys for taper bush according to ISO4183 and DIN2211 norms V型锥孔皮带轮

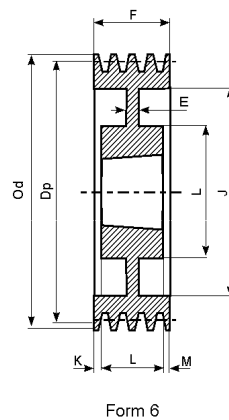
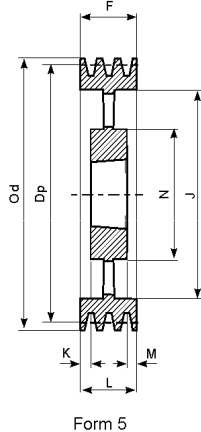
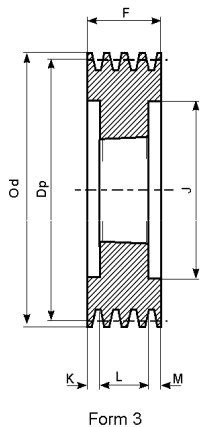

SPB - 6

Description 型号	Dp. 节径	Od. 外径	Form 结构	Bush No. 锥孔号	Max Bore 最大内孔	E	F	J	K	L	M	N
SPB 140x6	140	147	3	2517	60	-	120	100	37,5	45	37,5	-
SPB 150x6	150	157	3	2517	60	-	120	107	37,5	45	37,5	-
SPB 160x6	160	167	3	3020	75	-	120	117	34,5	51	34,5	-
SPB 170x6	170	177	3	3020	75	-	120	127	34,5	51	34,5	-
SPB 180x6	180	187	3	3020	75	-	120	137	34,5	51	34,5	-
SPB 190x6	190	197	3	3020	75	-	120	147	34,5	51	34,5	-
SPB 200x6	200	207	3	3020	75	-	120	157	34,5	51	34,5	-
SPB 212x6	212	219	3	3535	90	-	120	169	15,5	89	15,5	-
SPB 224x6	224	231	3	3535	90	-	120	181	15,5	89	15,5	-
SPB 236x6	236	243	3	3535	90	-	120	193	15,5	89	15,5	-
SPB 250x6	250	257	3	3535	90	-	120	207	15,5	89	15,5	-
SPB 280x6	280	287	6	3535	90	25	120	237	15,5	89	15,5	175
SPB 300x6	300	307	6	3535	90	25	120	257	15,5	89	15,5	175
SPB 315x6	315	322	6	3535	90	25	120	272	15,5	89	15,5	175
SPB 335x6	335	342	6	3535	90	25	120	292	15,5	89	15,5	175
SPB 355x6	355	362	6	3535	90	25	120	312	15,5	89	15,5	175
SPB 400x6	400	407	5	3535	90	-	120	357	15,5	89	15,5	175
SPB 450x6	450	457	5	4040	100	-	120	407	-	102	18	210
SPB 500x6	500	507	5	4040	100	-	120	457	-	102	18	210
SPB 560x6	560	567	5	4040	100	-	120	517	-	102	18	210
SPB 630x6	630	637	5	4040	100	-	120	587	-	102	18	210
SPB 710x6	710	717	5	4040	100	-	120	664	9	102	9	210
SPB 800x6	800	807	5	4545	110	-	120	754	3	114	3	242
SPB 900x6	900	907	5	4545	110	-	120	854	3	114	3	242
SPB 1000x6	1000	1007	5	4545	110	-	120	954	3	114	3	242
SPB 1250x6	1250	1257	5	4545	110	-	120	1204	3	114	3	242

KOBEI

V-Belt pulleys for taper bush according to ISO4183 and DIN2211 norms V型锥孔皮带轮

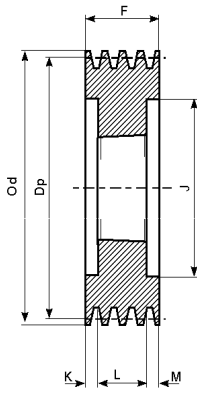

Form 3

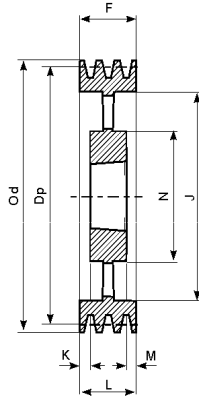

Form 5

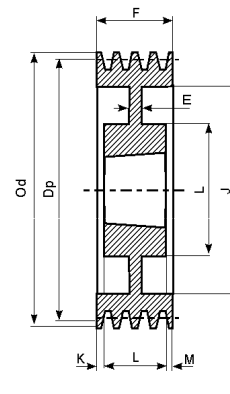

Form 6

SPB - 8

Description 型号	Dp. 节径	Od. 外径	Form 结构	Bush No. 锥孔号	Max Bore 最大内孔	E	F	J	K	L	M	N
SPB 140x8	140	147	3	2517	60	-	158	97	37,5	45	37,5	-
SPB 160x8	160	167	3	3020	75	-	158	117	53,5	51	53,5	-
SPB 170x8	170	177	3	3030	75	-	158	127	41	76	41	-
SPB 180x8	180	187	3	3030	75	-	158	137	41	76	41	-
SPB 190x8	190	197	3	3030	75	-	158	147	41	76	41	-
SPB 200x8	200	207	3	3535	90	-	158	157	34,5	89	34,5	-
SPB 212x8	212	219	3	3535	90	-	158	169	34,5	89	34,5	-
SPB 224x8	224	231	3	3535	90	-	158	181	34,5	89	34,5	-
SPB 236x8	236	243	3	3535	90	-	158	193	34,5	89	34,5	-
SPB 250x8	250	257	3	3535	90	-	158	207	34,5	89	34,5	-
SPB 280x8	280	287	6	3535	90	25	158	237	34,5	89	34,5	175
SPB 300x8	300	307	6	3535	90	25	158	257	34,5	89	34,5	175
SPB 315x8	315	322	6	3535	90	25	158	272	34,5	89	34,5	175
SPB 335x8	335	342	6	3535	90	25	158	292	34,5	89	34,5	175
SPB 355x8	355	362	6	3535	90	25	158	312	34,5	89	34,5	175
SPB 400x8	400	407	6	4040	100	30	158	357	28	102	28	210
SPB 450x8	450	457	5	4040	100	-	158	407	28	102	28	210
SPB 500x8	500	507	5	4040	100	-	158	457	28	102	28	210
SPB 560x8	560	567	5	4545	110	-	158	517	22	114	22	242
SPB 630x8	630	637	5	4545	110	-	158	587	22	114	22	242
SPB 710x8	710	717	5	4545	110	-	158	664	22	114	22	242
SPB 800x8	800	807	5	4545	110	-	158	754	22	114	22	242
SPB 900x8	900	907	5	4545	110	-	158	854	22	114	22	242
SPB 1000x8	1000	1007	5	5050	110	-	158	954	15,5	127	15,5	267
SPB 1250x8	1250	1257	5	5050	110	-	158	1204	15,5	127	15,5	267

V-Belt pulleys for taper bush according to ISO4183 and DIN2211 norms V型锥孔皮带轮

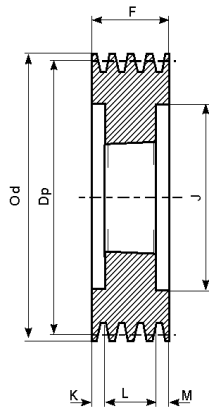

Form 3

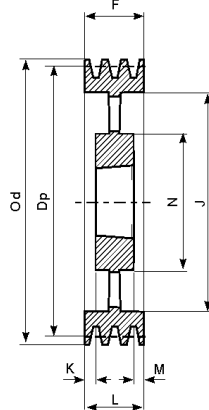

Form 5

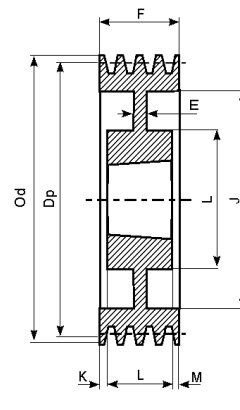

Form 6

SPB - 10

Description 型号	Dp. 节径	Od. 外径	Form 结构	Bush No. 锥孔号	Max Bore 最大内孔	E	F	J	K	L	M	N
SPB 224x10	224	231	3	3535	90	-	196	181	53,5	89	53,5	-
SPB 236x10	236	243	3	3535	90	-	196	193	53,5	89	53,5	-
SPB 250x10	250	257	3	3535	90	-	196	207	53,5	89	53,5	-
SPB 280x10	280	287	6	3535	90	30	196	237	53,5	89	53,5	175
SPB 315x10	315	322	6	3535	90	30	196	272	53,5	89	53,5	175
SPB 335x10	335	342	6	4040	100	30	196	292	47	102	47	210
SPB 355x10	355	362	6	4040	100	30	196	312	47	102	47	210
SPB 400x10	400	407	6	4040	100	30	196	357	47	102	47	210
SPB 450x10	450	457	5	4545	110	-	196	407	41	114	41	242
SPB 500x10	500	507	5	4545	110	-	196	457	41	114	41	242
SPB 560x10	560	567	5	4545	110	-	196	517	41	114	41	242
SPB 630x10	630	637	5	4545	110	-	196	587	41	114	41	242
SPB 710x10	710	717	5	4545	110	-	196	664	41	114	41	242
SPB 800x10	800	807	5	4545	110	-	196	754	41	114	41	242
SPB 900x10	900	907	5	5050	125	-	196	854	34,5	127	34,5	267
SPB 1000x10	1000	1007	5	5050	125	-	196	954	34,5	127	34,5	267
SPB 1250X10	1250	1257	5	5050	125	-	196	1204	34,5	127	34,5	267

KOBEI

V-Belt pulleys for taper bush according to ISO4183 and DIN2211 norms V型锥孔皮带轮

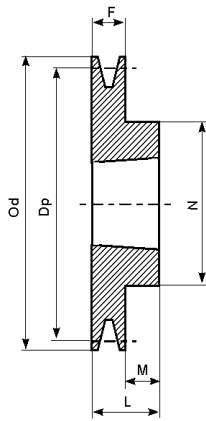

Form 1

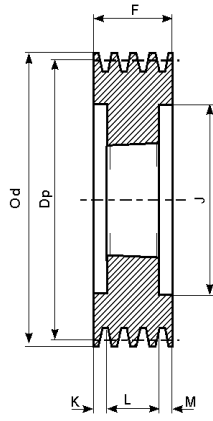

Form 3

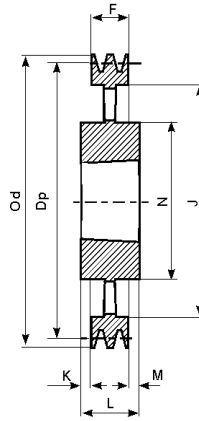

Form 4

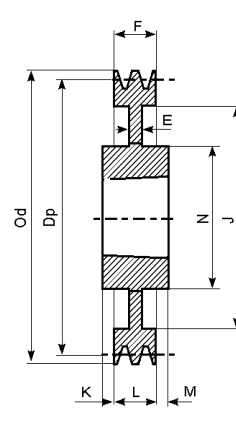

Form 7

SPC - 3

Description 型号	Dp. 节径	Od. 外径	Form 结构	Bush No. 锥孔号	Max Bore 最大内孔	E	F	J	K	L	M	N
SPC 200x3	200	209,6	3	2517	60	-	85	144	20	45	20	-
SPC 212x3	212	221,6	3	3020	75	-	85	156	17	51	17	-
SPC 224x3	224	233,6	3	3020	75	-	85	168	17	51	17	-
SPC 236x3	236	245,6	3	3020	75	-	85	180	17	51	17	-
SPC 250x3	250	259,6	3	3020	75	-	85	194	17	51	17	-
SPC 265x3	265	274,6	1	3535	90	-	85	209	-	89	4	175
SPC 280x3	280	289,6	1	3535	90	-	85	224	-	89	4	175
SPC 300x3	300	309,6	7	3535	90	20	85	244	2	89	2	175
SPC 315x3	315	324,6	7	3535	90	20	85	259	2	89	2	175
SPC 335x3	335	344,6	7	3535	90	20	85	279	2	89	2	175
SPC 355x3	355	364,6	7	3535	90	20	85	299	2	89	2	175
SPC 375x3	375	384,6	7	3535	90	25	85	319	2	89	2	175
SPC 400x3	400	409,6	7	3535	90	17	85	344	2	89	2	175
SPC 425x3	425	434,6	7	3535	90	17	85	369	2	89	2	175
SPC 450x3	450	459,6	4	3535	90	-	85	394	2	89	2	175
SPC 475x3	475	484,6	4	3535	90	-	85	419	2	89	2	175
SPC 500x3	500	509,6	4	3535	90	-	85	444	2	89	2	175
SPC 530x3	530	539,6	4	3535	90	-	85	474	2	89	2	175
SPC 560x3	560	569,6	4	3535	90	-	85	504	2	89	2	175
SPC 630x3	630	639,6	4	4040	100	-	85	574	8,5	102	8,5	210
SPC 800x3	800	809,6	4	4545	110	-	85	737	14,5	114	14,5	242
SPC 1000x3	1000	1009,6	4	5050	125	-	85	937	21	127	21	267
SPC 1250x3	1250	1259,6	4	5050	125	-	85	1187	21	127	21	267

KOBEI

V-Belt pulleys for taper bush according to ISO4183 and DIN2211 norms

V型锥孔皮带轮

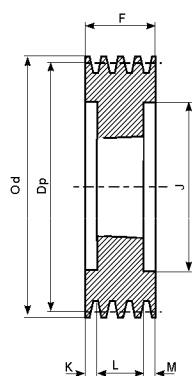

Form 3

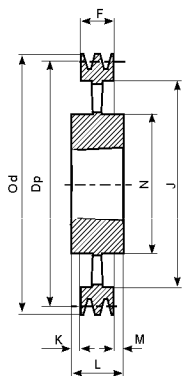

Form 4

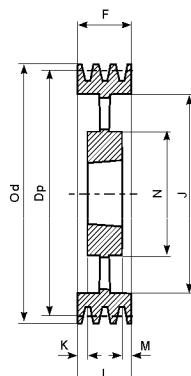

Form 5

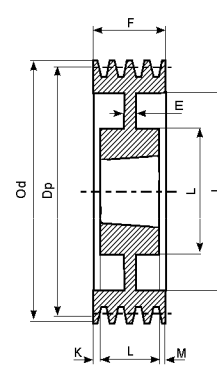

Form 6

SPC - 4

Description 型号	Dp. 节径	Od. 外径	Form 结构	Bush No. 锥孔号	Max Bore 最大内孔	E	F	J	K	L	M	N
SPC 200x4	200	209,6	3	3020	75	-	111	144	30	51	30	-
SPC 212x4	212	221,6	3	3020	75	-	111	156	30	51	30	-
SPC 224x4	224	233,6	3	3535	90	-	111	168	11	89	11	-
SPC 236x4	236	245,6	3	3535	90	-	111	180	11	89	11	-
SPC 250x4	250	259,6	3	3535	90	-	111	194	11	89	11	-
SPC 265x4	265	274,6	3	3535	90	-	111	209	11	89	11	-
SPC 280x4	280	289,6	6	3535	90	18	111	224	11	89	11	175
SPC 300x4	300	309,6	6	3535	90	20	111	244	11	89	11	175
SPC 315x4	315	324,6	6	3535	90	20	111	259	11	89	11	175
SPC 335x4	335	344,6	6	3535	90	20	111	279	11	89	11	175
SPC 355x4	355	364,6	6	3535	90	20	111	299	11	89	11	175
SPC 375x4	375	384,6	6	3535	90	25	111	319	11	89	11	175
SPC 400x4	400	409,6	6	3535	90	18	111	344	11	89	11	175
SPC 425x4	425	434,6	6	3535	90	18	111	369	11	89	11	175
SPC 450x4	450	459,6	5	3535	90	-	111	394	11	89	11	175
SPC 475x4	475	484,6	5	3535	90	-	111	419	11	89	11	175
SPC 500x4	500	509,6	5	3535	90	-	111	444	11	89	11	175
SPC 530x4	530	539,6	5	4040	100	-	111	474	4,5	102	4,5	210
SPC 560x4	560	569,6	5	4040	100	-	111	504	4,5	102	4,5	210
SPC 630x4	630	639,6	4	4545	110	-	111	574	1,5	114	1,5	242
SPC 710x4	710	719,6	4	5050	125	-	111	654	8	127	8	267
SPC 800x4	800	809,6	4	5050	125	-	111	737	8	127	8	267
SPC 1000x4	1000	1009,6	4	5050	125	-	111	937	8	127	8	267
SPC 1250x4	1250	1259,6	4	5050	125	-	111	1187	8	127	8	267

V-Belt pulleys for taper bush according to ISO4183 and DIN2211 norms V型锥孔皮带轮

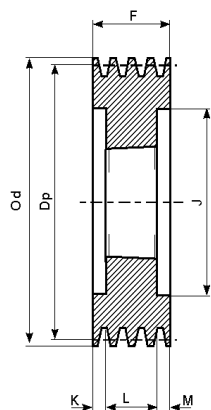

Form 3

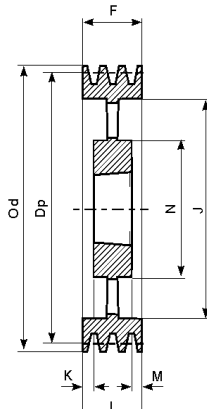

Form 5

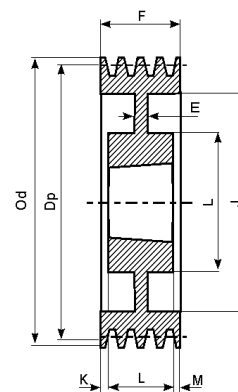

Form 6

SPC - 5

Description 型号	Dp. 节径	Od. 外径	Form 结构	Bush No. 锥孔号	Max Bore 最大内孔	E	F	J	K	L	M	N
SPC 200x5	200	209,6	3	3535	90	-	136	144	23,5	89	23,5	-
SPC 212x5	212	221,6	3	3535	90	-	136	156	23,5	89	23,5	-
SPC 224x5	224	233,6	3	3535	90	-	136	168	23,5	89	23,5	-
SPC 236x5	236	245,6	3	3535	90	-	136	180	23,5	89	23,5	-
SPC 250x5	250	259,6	3	3535	90	-	136	194	23,5	89	23,5	-
SPC 265x5	265	274,6	3	3535	90	-	136	209	23,5	89	23,5	-
SPC 280x5	280	289,6	3	3535	90	-	136	224	23,5	89	23,5	-
SPC 300x5	300	309,6	6	3535	90	20	136	244	23,5	89	23,5	175
SPC 315x5	315	324,6	6	3535	90	20	136	259	23,5	89	23,5	175
SPC 335x5	335	344,6	6	3535	90	20	136	279	23,5	89	23,5	175
SPC 355x5	355	364,6	6	3535	90	20	136	299	23,5	89	23,5	175
SPC 375x5	375	384,6	6	3535	90	25	136	319	23,5	89	23,5	175
SPC 400x5	400	409,6	6	3535	90	15	136	344	23,5	89	23,5	175
SPC 425x5	425	434,6	6	3535	90	20	136	369	23,5	89	23,5	175
SPC 450x5	450	459,6	5	4040	100	-	136	394	17	102	17	210
SPC 475x5	475	484,6	5	4040	100	-	136	419	17	102	17	210
SPC 500x5	500	509,6	5	4040	100	-	136	444	17	102	17	210
SPC 530x5	530	539,6	5	4545	110	-	136	474	11	114	11	240
SPC 560x5	560	569,6	5	4545	110	-	136	504	11	114	11	242
SPC 630x5	630	639,6	5	5050	125	-	136	574	4,5	127	4,5	267
SPC 710x5	710	719,6	5	5050	125	-	136	654	4,5	127	4,5	267
SPC 800x5	800	809,6	5	5050	125	-	136	737	4,5	127	4,5	267
SPC 1000x5	1000	1009,6	5	5050	125	-	136	937	4,5	127	4,5	267
SPC 1250x5	1250	1259,6	5	5050	125	-	136	1187	4,5	127	4,5	267

KOBEI

V-Belt pulleys for taper bush according to ISO4183 and DIN2211 norms V型锥孔皮带轮

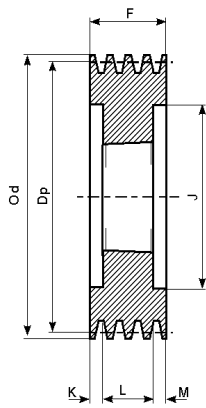

Form 3

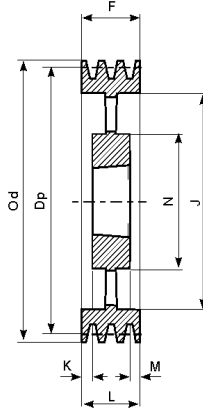

Form 5

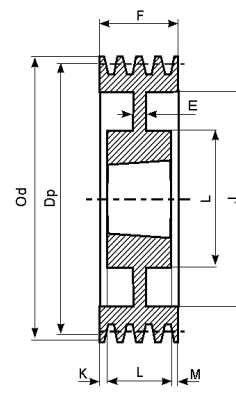

Form 6

SPC - 6

Description 型号	Dp. 节径	Od. 外径	Form 结构	Bush No. 锥孔号	Max Bore 最大内孔	E	F	J	K	L	M	N
SPC 200x6	200	209,6	3	3535	90	-	162	144	36,5	89	36,5	-
SPC 212x6	212	221,6	3	3535	90	-	162	156	36,5	89	36,5	-
SPC 224x6	224	233,6	3	3535	90	-	162	168	36,5	89	36,5	-
SPC 236x6	236	245,6	3	3535	90	-	162	180	36,5	89	36,5	-
SPC 250x6	250	259,6	3	3535	90	-	162	194	36,5	89	36,5	-
SPC 265x6	265	274,6	3	3535	90	-	162	209	36,5	89	36,5	-
SPC 280x6	280	289,6	6	3535	90	20	162	224	36,5	89	36,5	175
SPC 300x6	300	309,6	6	3535	90	20	162	244	36,5	89	36,5	175
SPC 315x6	315	324,6	6	3535	90	20	162	259	36,5	89	36,5	175
SPC 335x6	335	344,6	6	3535	90	20	162	279	36,5	89	36,5	175
SPC 355x6	355	364,6	6	3535	90	20	162	299	36,5	89	36,5	175
SPC 375x6	375	384,6	6	4040	100	30	162	319	30	102	30	210
SPC 400x6	400	409,6	6	4040	100	30	162	344	30	102	30	210
SPC 425x6	425	434,6	6	4040	100	30	162	369	30	102	30	210
SPC 450x6	450	459,6	6	4545	110	30	162	394	24	114	24	242
SPC 475x6	475	484,6	6	4545	110	30	162	419	24	114	24	242
SPC 500x6	500	509,6	5	4545	110	-	162	444	24	114	24	242
SPC 530x6	530	539,6	5	5050	125	-	162	474	17,5	127	17,5	265
SPC 560x6	560	569,6	5	5050	125	-	162	504	17,5	127	17,5	267
SPC 630x6	630	639,6	5	5050	125	-	162	574	17,5	127	17,5	267
SPC 710x6	710	719,6	5	5050	125	-	162	654	17,5	127	17,5	267
SPC 800x6	800	809,6	5	5050	125	-	162	737	17,5	127	17,5	267
SPC 1000x6	1000	1009,6	5	5050	125	-	162	937	17,5	127	17,5	267
SPC 1250x6	1250	1259,6	5	5050	125	-	162	1187	17,5	127	17,5	267

V-Belt pulleys for taper bush according to ISO4183 and DIN2211 norms V型锥孔皮带轮

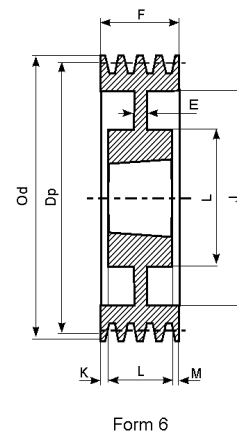
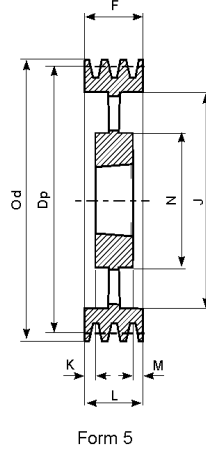
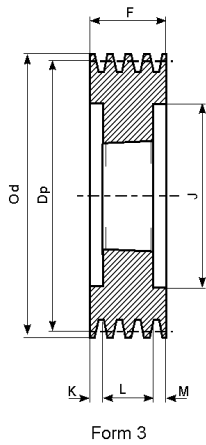

SPC - 8

Description 型号	Dp. 节径	Od. 外径	Form 结构	Bush No. 锥孔号	Max Bore 最大内孔	E	F	J	K	L	M	N
SPC 200x8	200	209,6	3	3535	90	-	213	144	62	89	62	-
SPC 212x8	212	221,6	3	3535	90	-	213	156	62	89	62	-
SPC 224x8	224	233,6	3	3535	90	-	213	168	62	89	62	-
SPC 236x8	236	245,6	3	3535	90	-	213	180	62	89	62	-
SPC 250x8	250	259,6	3	3535	90	-	213	194	62	89	62	-
SPC 265x8	265	274,6	3	3535	90	-	213	209	62	89	62	-
SPC 280x8	280	289,6	3	3535	90	-	213	224	62	89	62	-
SPC 300x8	300	309,6	3	4040	100	-	213	244	55,5	102	55,5	-
SPC 315x8	315	324,6	3	4040	100	-	213	259	55,5	102	55,5	-
SPC 335x8	335	344,6	6	4040	100	50	213	279	55,5	102	55,5	210
SPC 355x8	355	364,6	6	4040	100	40	213	299	55,5	102	55,5	210
SPC 375x8	375	384,6	6	4545	110	30	213	319	49,5	114	49,5	242
SPC 400x8	400	409,6	6	4545	110	30	213	344	49,5	114	49,5	242
SPC 425x8	425	434,6	6	4545	110	30	213	369	49,5	114	49,5	240
SPC 450x8	450	459,6	6	5050	125	30	213	394	43	127	43	267
SPC 475x8	475	484,6	6	5050	125	30	213	419	43	127	43	267
SPC 500x8	500	509,6	6	5050	125	30	213	444	43	127	43	267
SPC 530x8	530	539,6	6	5050	125	30	213	474	43	127	43	267
SPC 560x8	560	569,6	5	5050	125	-	213	504	43	127	43	267
SPC 630x8	630	639,6	5	5050	125	-	213	574	43	127	43	267
SPC 710x8	710	719,6	5	5050	125	-	213	654	43	127	43	267
SPC 800x8	800	809,6	5	5050	125	-	213	737	43	127	43	267
SPC 1000x8	1000	1009,6	5	5050	125	-	213	937	43	127	43	267
SPC 1250x8	1250	1259,6	5	5050	125	-	213	1187	43	127	43	267

KOBEI

V-Belt pulleys for taper bush according to ISO4183 and DIN2211 norms V型锥孔皮带轮

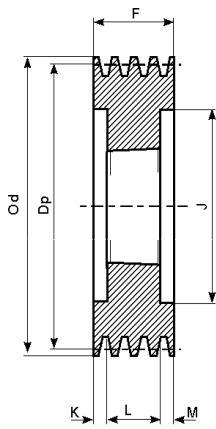

Form 3

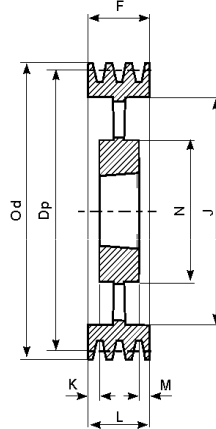

Form 5

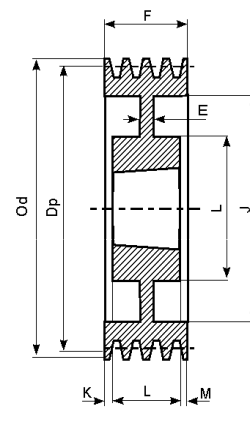

Form 6

SPC - 10

Description 型号	Dp. 节径	Od. 外径	Form 结构	Bush No. 锥孔号	Max Bore 最大内孔	E	F	J	K	L	M	N
SPC 250x10	250	259,6	3	4040	100	-	264	194	81	102	81	-
SPC 280x10	280	289,6	3	4040	100	-	264	224	81	102	81	-
SPC 300x10	300	309,6	3	4545	110	-	264	244	75	114	75	-
SPC 315x10	315	324,6	3	4545	110	-	264	259	75	114	75	-
SPC 355x10	355	364,6	3	4545	110	-	264	299	75	114	75	-
SPC 400x10	400	409,6	6	5050	125	70	264	344	68,5	127	68,5	267
SPC 450x10	450	459,6	6	5050	125	40	264	394	68,5	127	68,5	267
SPC 500x10	500	509,6	6	5050	125	40	264	444	68,5	127	68,5	267
SPC 560x10	560	569,6	5	5050	125	-	264	504	68,5	127	68,5	267
SPC 630x10	630	639,6	5	5050	125	-	264	574	68,5	127	68,5	267
SPC 710x10	710	719,6	5	5050	125	-	264	654	68,5	127	68,5	267
SPC 800x10	800	809,6	5	5050	125	-	264	737	68,5	127	68,5	267
SPC 1000x10	1000	1009,6	5	5050	125	-	264	937	68,5	127	68,5	267
SPC 1250x10	1250	1259,6	5	5050	125	-	264	1187	68,5	127	68,5	267