

Configuration by type

■ Before compression

■ After compression

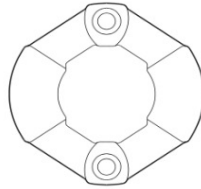
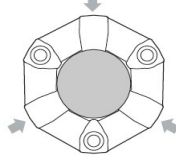
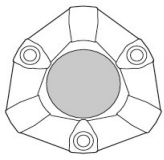

Size 001, 002

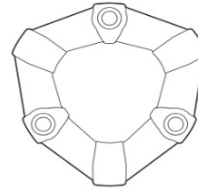

Size 004, 008, 016
025, 030, 090

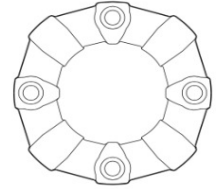

Size 012, 022, 028, 050
080, 140, 200, 250, 400

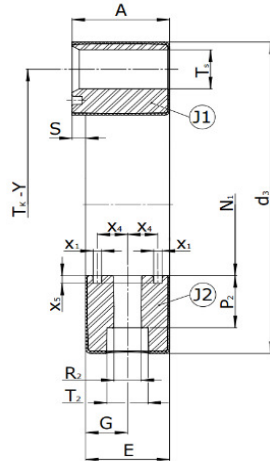
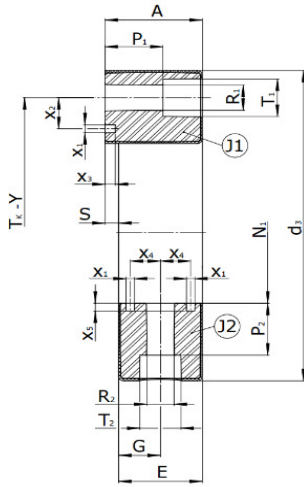

Size				Dimensions (mm)																
				A	d3	E	G	N1	P1	P2	R1	R2	S	T1	T2	X1	X2	X3	X4	X5
CF-A004	Screw	A	0	28	100	24	12	45	17	18.5	8.2	8.2	4	13.5	13.5	4	9	3	-	3
	Pin	AS	0-S	28	100	24	12	45	-	18.5	-	8.2	4	14	13.5	4	-	-	-	3
CF-A008	Screw	A	0	32	120	28	14	60	20.5	20.5	10.2	10.2	4	16.5	16.5	4	12	4	10	3
	Pin	AS	0-S	32	120	28	14	60	-	20.5	-	10.2	4	17.1	16.5	4	-	-	10	3
CF-A012	Screw	A	0	32	122	28	14	60	20.5	20.5	10.2	10.2	4	16.5	16.5	4	12	4	10	3
	Pin	AS	0-S	32	122	28	14	60	-	20.5	-	10.2	4	17.1	16.5	4	-	-	10	3
CF-A016	Screw	A	0	42	150	36	18	70	23.5	25.2	12.2	12.2	6	18.1	18.3	5	18	6	13.5	5
	Pin	AS	0-S	42	150	36	18	70	-	25.2	-	12.2	6	19.1	18.3	5	-	-	13.5	5
CF-A022	Screw	A	0	42	150	36	18	70	23.5	25.2	12.2	12.2	6	18.1	18.3	5	18	6	13.5	5
	Pin	AS	0-S	42	150	36	18	70	-	25.2	-	12.2	6	19.1	18.3	5	-	-	13.5	5
CF-A025	Screw	A	0	46	170	40	20	85	26	26	14.2	14.2	6	21.1	22	5	18	5	14	5
	Pin	AS	0-S	46	170	40	20	85	-	26	-	14.2	6	22	22	5	-	-	14	5
CF-A028	Screw	A	0	46	170	40	20	85	26	26	14.2	14.2	6	21.1	22	5	18	5	14	5
	Pin	AS	0-S	46	170	40	20	85	-	26	-	14.2	6	22.5	22	5	-	-	14	5
CF-A030	Screw	A	0	58	200	50	25	100	34.5	33.5	16.2	16.2	8	24.1	24.5	5	20	6	18	5
	Pin	AS	0-S	58	200	50	25	100	-	33.5	-	16.2	8	25	24.5	5	-	-	18	5
CF-A050	Screw	A	0	58	200	50	25	100	34.5	33.5	16.2	16.2	8	24.1	24.5	5	20	6	18	5
	Pin	AS	0-S	58	200	50	25	100	-	33.5	-	16.2	8	25.1	24.5	5	-	-	18	5
CF-A080	Screw	A	0	65	205	61	30.5	100	34.5	34.5	16.5	16.5	4	24.1	24.5	5	20	6	18	5
	Pin	AS	0-S	65	205	61	30.5	100	-	34.5	-	16.5	4	25.1	24.5	5	-	-	18	5
CF-A090	Screw	A	0	70	260	62	31	125	45	46	20.2	20.2	8	30.5	31	8	25	5	22.5	5
	Pin	AS	0-S	70	260	62	31	125	-	46	-	20.2	8	32	31	8	-	-	22.5	5
CF-A140	Screw	A	0	70	260	62	31	125	45	46	20.2	20.2	8	30.5	31	8	25	5	22.5	5
	Pin	AS	0-S	70	260	62	31	125	-	46	-	20.2	8	32.1	31	8	-	-	22.5	5
CF-A200	Screw	A	0	80	300	72	36	145	44	45.5	20.2	20.2	8	32	32	8	25	5	22.5	5
	Pin	AS	0-S	80	300	72	36	145	-	45.5	-	20.2	8	32.1	32	8	-	-	22.5	5
CF-A250	Screw	A	0	85	340	77	22.5	160	60	60	20.2	20.2	8	30.5	-	10	30	8	-	8
	Pin	AS	0-S	85	340	77	22.5	160	-	60	-	20.2	8	32.1	-	10	-	-	-	8